

GoStream

User Manual

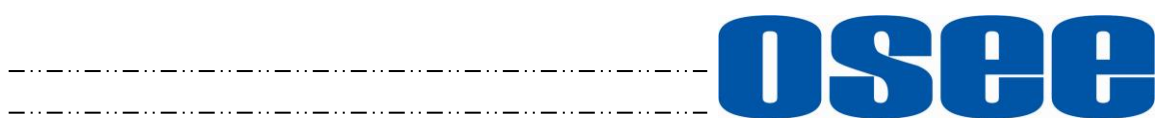

Product Information

Model: GoStream
Version: V010001
Release Date: April 11th, 2023

Company

OSEE TECHNOLOGY LTD.

Contact Information

Address: No.22 Building, No.68 zone, Beiqing Road, Haidian District, Beijing, China
Post Code: 100094
Tel: (+86) 010-62434168
Fax: (+86) 010-62434169
Web: <http://www.osee-dig.com/>
E-mail: sales@osee-dig.com

About this manual

Important

The following symbols are used in this manual:

Tips

- The further information or know-how for described subjects above which helps user to understand them better.
-

Warning

- The safety matters or operations that user must pay attention to when using this product.
-

Contents

The user manual applies to the following device types:

❖ **GoStream**

The images of GoStream are adopted in the following descriptions. Before reading the manual, please confirm the device type.

Contents

Contents	1
Chapter 1 Overview	1
Chapter 2 Safety.....	3
Chapter 3 Unpack and Installation	7
Chapter 4 Panel Layout and Device Features	9
4.1 GoStream Panel	10
4.1.1 Panel Layout.....	11
4.1.2 Function Areas	13
4.1.2.1 Power Control	13
4.1.2.2 Signal Sources.....	14
4.1.2.3 Audio Mix	17
4.1.2.4 Macro Control	19
4.1.2.5 Main Menu	20
4.1.2.6 Recording.....	22
4.1.2.7 PlayBack	22
4.1.2.8 Transition Control	23
4.1.2.9 Next Transition	29
4.1.3 Panel Operations.....	34
4.1.3.1 Display Multiview.....	34
4.1.3.2 Display Splicing-Super Source.....	37
4.1.3.3 Switching Sources Using a Cut.....	40
4.1.3.4 Switching Sources Using an Auto Transition.....	42
4.1.3.5 Fade to Black	44
4.1.3.6 Perform Manual Transition	45
4.1.3.7 Perform Preview Transition	46
4.1.3.8 Set Transition Rate and FTB Rate	49
4.1.3.9 Classifying- Keyer Control.....	50
4.1.3.10 Set Fill Source or Key Source	52
4.1.3.11 Set Luma Key or Linear key	54
4.1.3.12 Set Chroma Key	56
4.1.3.13 Set Pattern Key	57
4.1.3.14 Set PIP Key.....	59
4.1.3.15 Set and Adjust Mask	60
4.1.3.16 Perform Upstream/Downstream key Transition.....	61
4.1.3.17 Applying Audio Meter	67
4.1.3.18 How to Use Audio Mixer.....	69
4.1.3.19 How to Record and Run a Macro	74
4.1.3.20 Upload and Set Still Graph.....	76
4.1.3.21 How to Record and Play a Stream	78
4.1.3.22 Streaming and Broadcasting.....	83
4.1.3.23 Configuring a Stream Key	89

4.2 CONNECTORS.....	90
4.2.1 Rear Connectors Arrangement.....	90
4.2.2 Rear Connectors Operations.....	91
4.2.3 GoStream Control Software on PC.....	98
4.3 Support Format	99
Chapter 5 MENU OPERATIONS	101
5.1 Main Menu.....	102
5.1.1 Color Back Settings	103
5.1.2 Super Source Settings.....	105
5.1.3 Key Type Settings.....	108
5.1.4 Luma KEY Settings.....	110
5.1.5 Chroma KEY Settings.....	112
5.1.6 Key Pattern Settings	114
5.1.7 PIP Settings.....	117
5.1.8 Transition Settings	119
5.1.9 DSK Settings	121
5.1.10 FTB Settings	123
5.1.11 Audio Mixer Settings.....	125
5.1.12 Still Generator Settings	129
5.1.13 Macro Settings.....	130
5.1.14 Stream Settings	131
5.1.15 PlayBack Settings.....	136
5.1.16 System Settings.....	138
5.1.16.1 Set Recording & Streaming Quality.....	142
5.1.16.2 Set AUX Source	144
5.1.16.3 Set File Name for recording file.....	144
5.1.16.4 Set Output Format.....	144
5.1.16.5 Set Output Source.....	145
5.1.16.6 Restoring your Settings.....	145
5.2 Menu Settings.....	146
Chapter 6 Specifications	149

Chapter 1 Overview

GoStream has been designed to act as a compact, easy-to-use live switcher. The device supports switch a HDMI source with toned audio and transition effects to livestream to Facebook Live, Twitch, YouTube Live, and other social sites, or can be used to create a webcam source for Microsoft Teams, Skype, Zoom, OBS Studio and other conferencing or broadcasting software.

GoStream provides 4 standards HDMI inputs, 4 SDI inputs, 2 HDMI outputs, 1 USB webcam output and 1 USB webcam input, 1 Ethernet, 2 mic inputs and a headphone connection. There are plenty of transitions effects, green screen chroma keyer, PIP keyer, pattern keyer, luma keyer, linear keyer, etc. It also includes audio mixer, 32 still images, recording to USB disks in H.264 format, a built in hardware streaming engine(via Ethernet) for YouTube Live, Facebook, Twitch and more. You can monitor the output on a single monitor or a multiview with 4 HDMI inputs, media, preview and program plus status of recording, streaming and audios.

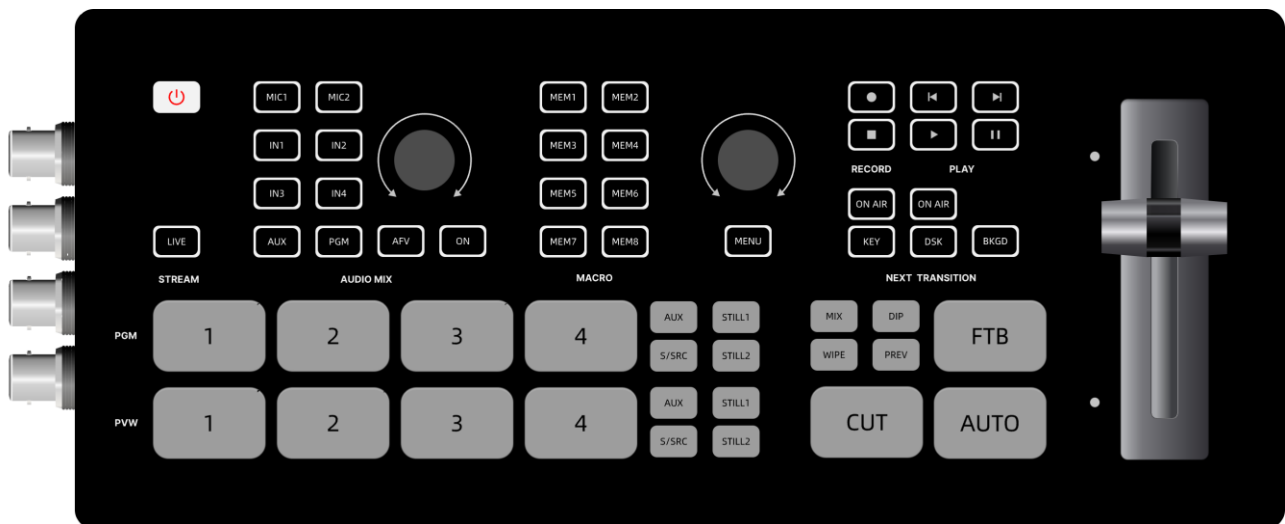

Features

- Support versatile operation interfaces: Rear view with control buttons on front panel, T Bar and Operation Menu
- Support selectable outputs from external cameras, videos or still images from SD card, supersource, internal color or black generators etc.
- Support FHD/HD multi-formats
- Support 6 channels of video inputs: 4 HDMI inputs, 1 USB webcam input and videos from SD card
- Support 2 HDMI outputs as a single view or a multiview, 1 USB webcam output

- Support audio input/output, audio mixer function
- Provide a flexible navigation menu to configure various settings
- Frame synchronizer for all inputs
- Support extensive title functions by multiple keyers: chroma keyer, PIP keyer, pattern keyer, luma keyer, linear keyer
- Provide versatile video transition effects(dip, wipe, mix, dve, etc.)
- Multi-use for SD card: Record, PlayBack and Update
- Support remote live streaming and broadcasting

Chapter 2 Safety

FCC Caution:

Any Changes or modifications not expressly approved by the party responsible for compliance could void the user's authority to operate the equipment.

This device complies with part 15 of the FCC Rules.

Operation is subject to the following two conditions: (1) This device may not cause harmful interference, and (2) this device must accept any interference received, including interference that may cause undesired operation.

Note: This equipment has been tested and found to comply with the limits for a Class B digital device, pursuant to part 15 of the FCC Rules. These limits are designed to provide reasonable protection against harmful interference in a residential installation. This equipment generates uses and can radiate radio frequency energy and, if not installed and used in accordance with the instructions, may cause harmful interference to radio communications. However, there is no guarantee that interference will not occur in a particular installation. If this equipment does cause harmful interference to radio or television reception, which can be determined by turning the equipment off and on, the user is encouraged to try to correct the interference by one or more of the following measures:

Reorient or relocate the receiving antenna.

Increase the separation between the equipment and receiver.

Connect the equipment into an outlet on a circuit different from that to which the receiver is connected.

Consult the dealer or an experienced radio/TV technician for help.

Warnings:

Read, keep and follow all of these instructions for your safety. Heed all warnings.

Warning

Device

- Do not beat with a hard object or scratch the device.
 - Install in accordance with the manufacturer's instructions.
 - Refer all servicing to qualified service personnel. Servicing will be required under all of the following conditions:
 - The unit has been exposed to rain or moisture.
 - Liquid had been spilled or objects have fallen onto the unit.
 - The unit has been damaged in any way, such as when the power-supply cord or plug is damaged.
 - The unit does not operate normally.
 - Clean only with dry cloth.
 - Specifications are subject to change without notice.
-

Warning

Position

- Do not block any ventilation openings.
 - Do not use this unit near water.
 - Do not expose the unit to rain or moisture.
 - Do not use this unit near any heat sources such as radiators, heat registers, stoves, or other apparatus (including amplifiers) that product heat.
 - A nameplate indicating operating voltage, etc., is located on the rear panel.
 - The socket-outlet shall be installed near the equipment and shall be easily accessible.
-

Warning

Power Supply Cord

- Do not defeat the safety purpose of the polarized or grounding-type plug.
 - Do not damage the power cord, place heavy objects on the power cord, stretch the power cord, or bend the power cord.
 - Protect the power cord from being walked on or pinched, particularly at plugs, convenience receptacles, and the point where they exit from the unit.
 - If the power cord is damaged, turn off the power immediately. It is dangerous to use the unit with a damaged power cord. It may cause fire or electric shock.
 - Unplug this unit during lightning storms or when unused for long periods of time.
 - Disconnect the power cord from AC outlet by grasping the plug, not by pulling the cord.
 - Should any solid object or liquid fall into the cabinet, unplug the unit and have it checked by qualified personnel before operating it any further.
-

Chapter 3 Unpack and Installation

Unpack:

When unpacking the components of GoStream, please verify that none of the components listed in Table 3.1 are damaged or lack. If there is any missing, contact your distributors or Osee Technology Ltd. for it.

Table 3-1 Packing List

No.	Item	Quantity
1	GoStream	1
2	Power cord	1
3	Quick Start Guide	1
4	Service Card	1

Installation:

1. Prepare for installation

Please follow the procedures below before installing GoStream:

- Check the equipment for any invisible damage that may have occurred during transit.
 - Confirm all the items listed on the packing list have been received.
 - Remove all the packing material including electrostatic-resistant packing.
 - Retain these packing materials for future use.
2. **Mount a GoStream in your desired location. Adequate ventilation is required when installed to prevent possible damage to the GoStream.**
 3. **Connect required cables for signal input and output.**
 4. **Connect 12VDC using the power cord.**
 5. **Connect the power cord to the power interface.**
 6. **Fasten the power protect accessory.**
 7. **As a final step, turn on the device by pressing the corresponding power button located on the front panel.**



- Please use the power cord supplied to avoid unnecessary trouble.
-

Chapter 4 Panel Layout and Device Features

GoStream displays the multiview image with a group of views on screen through the HDMI OUT2 interface after connecting the inputs and outputs and powered on. This feature provides a very convenient overview for monitoring all sources and outputs simultaneously, including the program and preview outputs, all HDMI inputs, AUX sources stored in SD card, still images, and audio levels plus disk recording status and stream dynamics indicators.

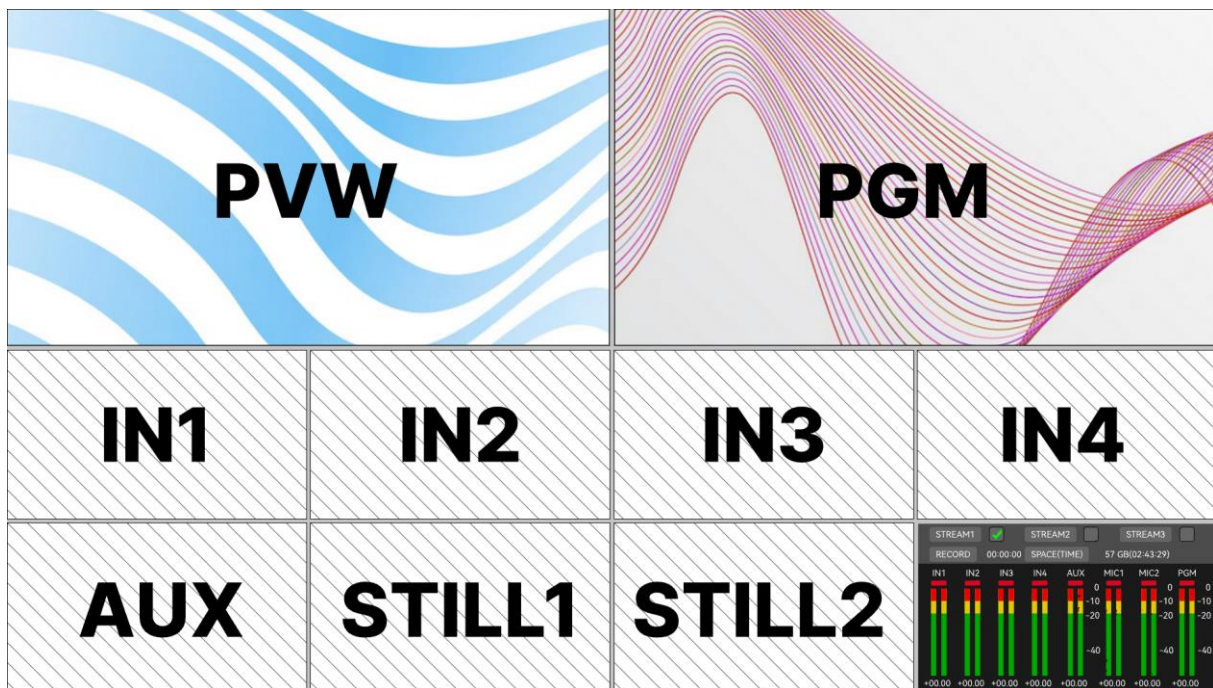

Figure 4-1 Multiview

Tips

- Refer to "4.1.3.1 Display Multiview" for more details about Multiview.

Press **MENU** button on the switcher panel, it will load the main menu pane on the bottom right in the multiview interface, as shown in Figure 4-2:

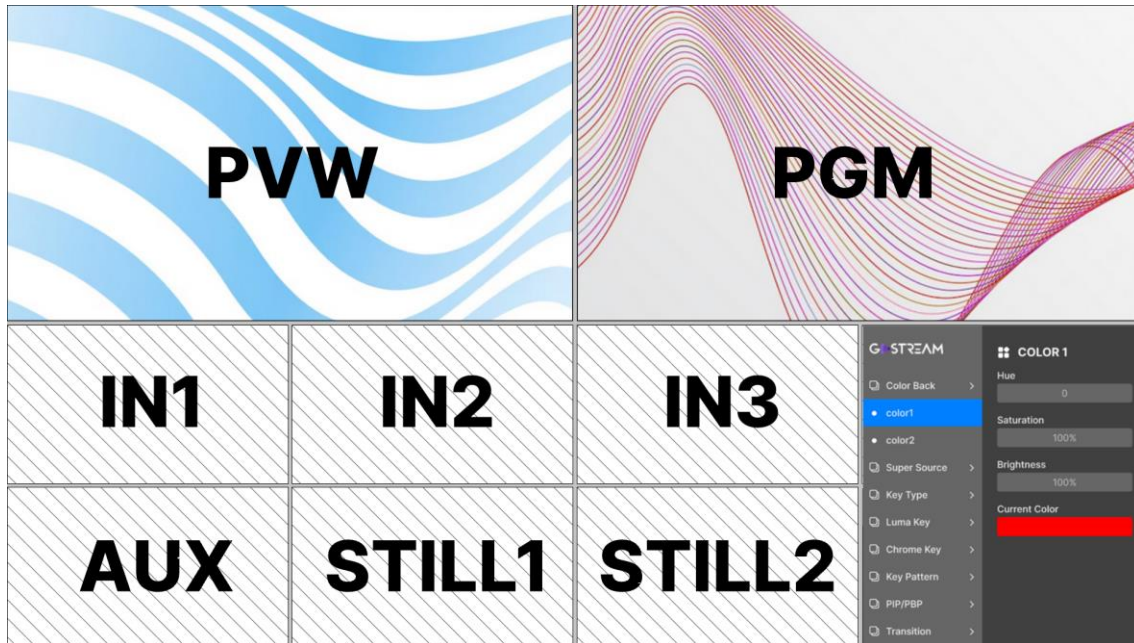

Figure 4-2 Main Menu

Tips

- Refer to "Chapter 5 MENU OPERATIONS" for details about the main menu.

4.1 GoStream Panel

GoStream is composed of multiple controls buttons with internal indicators, and provides a T bar for manual transition control on the right side. You can see the panel is divided into several areas and labeled as STREAM, AUDIO MIX, MACRO, RECORD, PLAY, NEXT TRANSITION and so on, which is according to its various functions. It will introduce these areas and their buttons' function in the following section.

4.1.1 Panel Layout

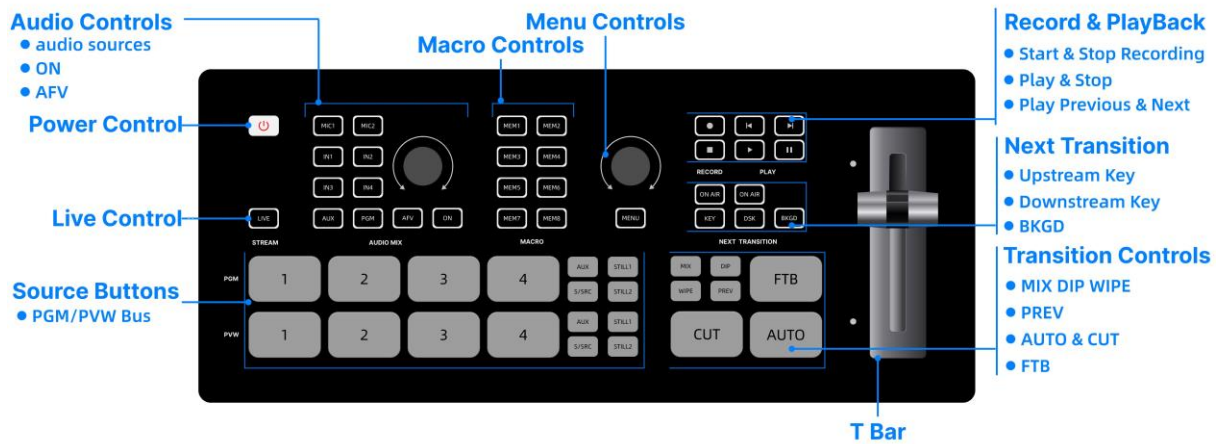

Figure 4.1-1 GoStream Panel

As shown in Figure 4.1-1, these areas are divided as: power control, signal control, audio mix, macro control, record and play, transition, next transition, live and menu. And there are groups of buttons in each area, as shown in the table below:

Area	Button	Description	Area	Button	Description
Power Control	POWER	Power on or off	Transition	MIX	Mix style
STREAM	LIVE	Stream on air		DIP	Dip style
Signal sources- PGM	1	HDMI1/SDI1 input		WIPE	Wipe style
	2	HDMI2/SDI2 input		PREV	Preview Transition
	3	HDMI3/SDI3 input		FTB	Fade to black
	4	HDMI4/SDI4 input		CUT	Cut Transition
	AUX	Auxiliary signal		AUTO	Auto Transition
	S/SRC	Internal Black signal/Super Source	T Bar	Manual transition	
Signal sources- PVW	1	HDMI1/SDI1 input	Main Menu	MENU	Main Menu
	2	HDMI2/SDI2 input		Knob	Adjust Menu
	3	HDMI3/SDI3 input	MACRO	MEM1	Macro command 1
	4	HDMI4/SDI4 input		MEM2	Macro command 2
	AUX	Auxiliary signal		MEM3	Macro command 3
	S/SRC	Internal Black		MEM4	Macro command 4
			MEM5	Macro command 5	
			MEM6	Macro command 6	

Area	Button	Description	Area	Button	Description
		signal/Super Source			
	STILL	Still image 1		MEM7	Macro command 7
	STILL	Still image 2		MEM8	Macro command 8
AUDIO MIX	MIC1	MIC1 input	NEXT Transition	ON AIR	On air or off air
	MIC2	MIC2 input		KEY	Upstream Key
	IN1	Embedded HDMI1/SDI1		ON AIR	On air or off air
	IN2	Embedded HDMI2/SDI2		DSK	Downstream Key
	IN3	Embedded HDMI3/SDI3		BKGD	Background
	IN4	Embedded HDMI4/SDI4	RECORD	Start	Start recording
	AUX	Auxiliary signal		Stop	Stop recording
	PGM	Choose an audio source through audio mixer menu	PLAY	Start	Start playing
	AFV	Audio follows video		Pause	Pause playing
	ON	Enable/Disable audio channel		Previous	Previous
	Knob	Adjust Audio		Next	Next

- Power Control: Switch the device on or off;
- Signal Control: This block is divided into two areas including program bus and preview bus;
- Audio Control: Choose audio source for audio mixing and adjust audio levels;
- Macro Control: To record and execute macro commands;
- Record Control: Start or stop recording;
- Play Control: Play the recorded videos in SD card;
- Transition Control: Switch video sources by cut transition, effect transition or manual transition;
- Next Transition Control: Set the upstream or downstream keyer in the next transition;

- Live Control: Stream on live;
- Menu Control: Set detailed parameters for the switcher's functions.

Tips

- All buttons on the panel have indicators, and the button will display in various color according to its real-time status.

4.1.2 Function Areas

The panel is divided into several areas according to operations and functions.

4.1.2.1 Power Control

Press the power button at the top left corner of the panel to switch the device on or off, as shown in Figure 4.1-2.

- **Power on or off**

Short press the power button to switch it on, the button is highlighted in white during started, then it will turn grey after started successful. After that, long press it again for 3~4s to shut it down.

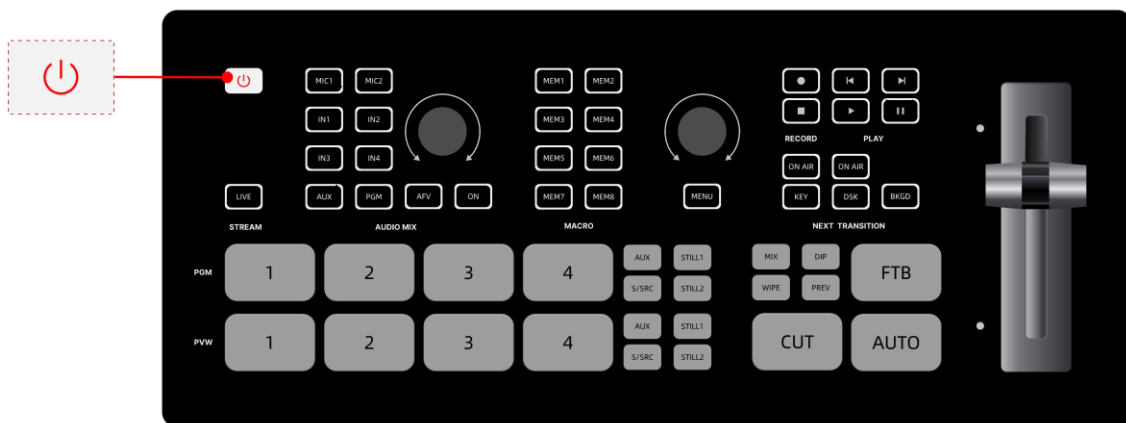

Figure 4.1-2 Power Buttons

Tips

- The power button is illuminated in highlighted white during startup with its internal light.

4.1.2.2 Signal Sources

Press a signal source button to switch **PGM** or **PVW** source.

In this area, the signal sources are divided into two areas including the background sources of program bus and preview bus. The buttons in the first row are program bus, and the second row are preview bus.

Each bus is composed of 8 background source select buttons: four channels of HDMI/SDI inputs, two channels of still image, one channel of auxiliary signal from SD card or USB connector (usually labeled as AUX in this text), and one internal black signal (also could be set as Super Source- a splicing display), the buttons are as shown in Figure 4.1-3:

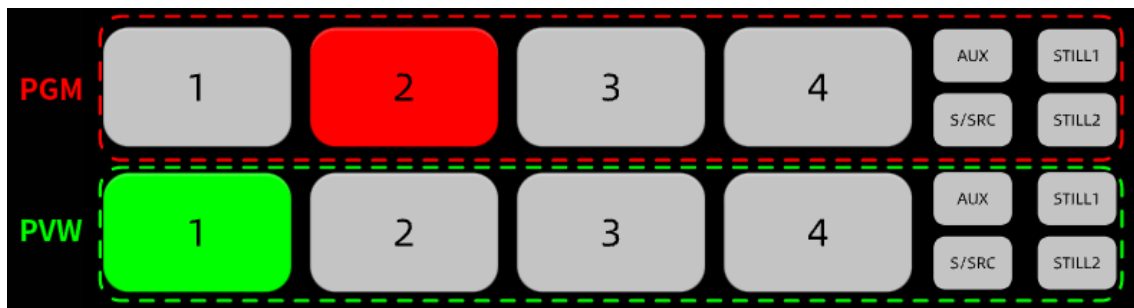

Figure 4.1-3 Source Select Buttons

To switch among these sources, press any one of the buttons in PGM bus or PVW bus.

■ Program Bus Source Select Buttons (Program output, labeled as PGM)

Press a program bus source select button, and GoStream will switch the program output immediately. You can see the **PGM** window changing immediately and no effect on the **PVW** window.

The program bus source select buttons are used to switch background sources directly to the program output. The source currently on air is indicated by a button that is illuminated red.

As shown in Figure 4.1-3, the source buttons labeled in the dotted red rectangle are all background sources on program bus.

And you can monitor the current program video in the **PGM** window of multiview display, as shown in Figure 4.1-4, the window labeled in red rectangle in Row2 is the program source currently on air.

■ Preview Bus Source Select Buttons (Preview output, labeled as PVW)

Press a preview bus source select button, and GoStream will switch the preview output immediately. You can see the **PVW** window changing immediately and no

effect on the **PGW** window. (BKGD is ON)

In program preview switching mode, the preview bus source select buttons are used to choose a background source on the preview output, this source will be sent to the program bus when the next transition occurs. The currently selected preview source is indicated by a button that is illuminated green.

As shown in Figure 4.1-3, the source buttons labeled in the dotted green rectangle are all background sources on preview bus.

And you can monitor the current preview video in the **PVW** window of multiview display, as shown in Figure 4.1-4, the window labeled in green rectangle in Row3 is the preview source currently selected.

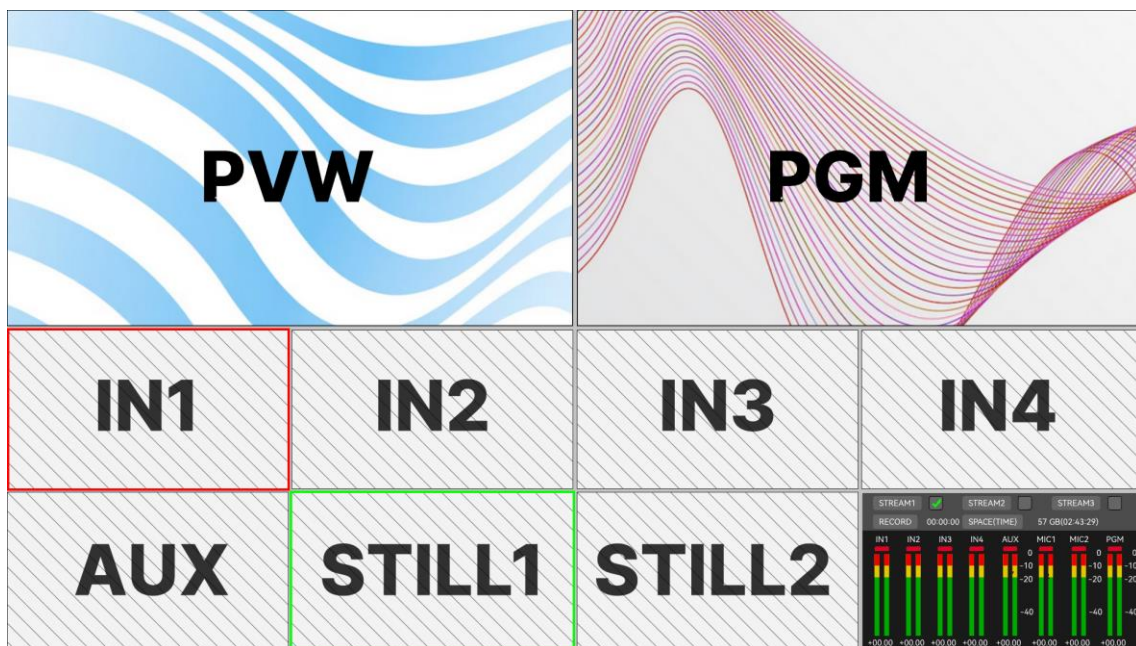

Figure 4.1-4 PGM View and PVW View

i Tips

- The source selected on the program bus is displayed directly to the program output. You can change the program output immediately as soon as you press a program bus source select button.
- A red border indicates the source is used on the program output and a green border indicates a source is selected on the preview output.
- Press a button with transition function, the source selected in the preview bus will be sent to the program bus when the transition occurs. (BKGD is ON)
- Refer to "4.1.3.1 Display Multiview" for details on multiview display.

The buttons in signal sources areas are described as the table below. Press a signal button, it will switch to this source immediately.

Table 4.1-1 Signal Source Buttons

Labeled	Button		Button Description
	PGM	PVW	
1	IN1	IN1	Signal from HDMI1/SDI1 connector
2	IN2	IN2	Signal from HDMI2/SDI2 connector
3	IN3	IN3	Signal from HDMI3/SDI3 connector
4	IN4	IN4	Signal from HDMI4/SDI4 connector
AUX	AUX	AUX	Internal media played. You can set this source via Settings →src selection → Aux as UVC, SD card or NDI.
S/SRC	S/SRC	S/SRC	The internal black signal. Or you can set a splicing display on this button through Super Source menu.
STILL	STILL	STILL	Load a still graph as signal. Set still1 in Still Generator menu.
STILL	STILL	STILL	Load a still graph as signal. Set still2 in Still Generator menu.

Tips

- The source selection buttons for the program bus match the preview bus.
- Particularly, the default signal on **S/SRC button** is an internal black signal, set the menu item **super source**→**enable** to be ON, and it will display a splicing image connecting to **S/SRC button**.
- **BKGD** button is used to enable or disable the output of the background source. Refer to "4.1.2.9 Next Transition" for more details about **BKGD** button.

4.1.2.3 Audio Mix

Use the buttons in Audio Mix area to select audio source for output and adjust audio levels.



Figure 4.1-5 Buttons in Audio Mix Area

Button	Description	Button	Description
MIC1	Audio source from MIC1 connector	MIC2	Audio source from MIC2 connector
IN1	Embedded audio source from HDMI1/SDI1	IN2	Embedded audio source from HDMI2/SDI2
IN3	Embedded audio source from HDMI3/SDI3	IN4	Embedded audio source from HDMI4/SDI4
AUX	Choose an audio source through audio mixer menu	PGM	Mixed audio output, Embedded audio source from PGM output
ON	Enable/Disable audio channel	Audio Knob	Adjust volume or mute
AFV	Audio follows video		

■ **Switch on or off Audio input**

ON: When the input’s audio is set to ‘on’, the input audio will be heard permanently, even if the source is not currently on air. This button is highlighted in white.

OFF: When the input’s audio is set to ‘off’, the input audio will never be heard even if the source video is on air. This button is in gray.

There is only one **ON** button in the Audio Mix area, but you can use it to match with each audio source button to switch on or off the paired audio input.

In audio meter view, the tally is red when the audio channel is selected as ON, and it is gray when the audio channel is selected as OFF.

■ **Audio Follows Video**

AFV stands for '**Audio Follows Video**'. Press it On, and it will only let the audio input be heard whenever the corresponding video source is switched on air.

The button is available for **IN1~IN4** and **AUX**.

There is only one AFV button in the Audio Mix area, but you can use it to match with each audio source button to switch on or off the paired audio input.

In audio meter view, the tally is green when the audio channel is selected as AFV.

■ **Select Audio Source**

It provides audio sources including **MIC 1**, **MIC 2**, **IN1**, **IN2**, **IN3**, **IN4** and **AUX**. Press an audio source button at first, then press **ON** to enable the corresponding channel of audio source. The audio source button will be highlighted in white after you press it.

Press **MENU** button followed by pressing an audio source button, it will pop up the submenu of this audio channel directly, this is very helpful for setting the latest audio channel you have selected.

■ **Adjust Volume**

Rotate the volume knob in clockwise or counterclockwise to increase or decrease volume output.

■ **Mute**

Press the volume knob straight down to mute the volume output.

■ **Set Audio Parameters**

Select **Audio Mixer**→**channel to set parameters for audio input and output.

■ **Audio Meter**

The audio meter view is displayed at the right bottom of the multiview, as shown in Figure 4.1-6. Each video source has an audio bar in this window, and you can check its audio level.

The corresponding parameters for each audio channel bar could be set in Audio Mixer menu. Refer to Audio Mixer menu for the details.

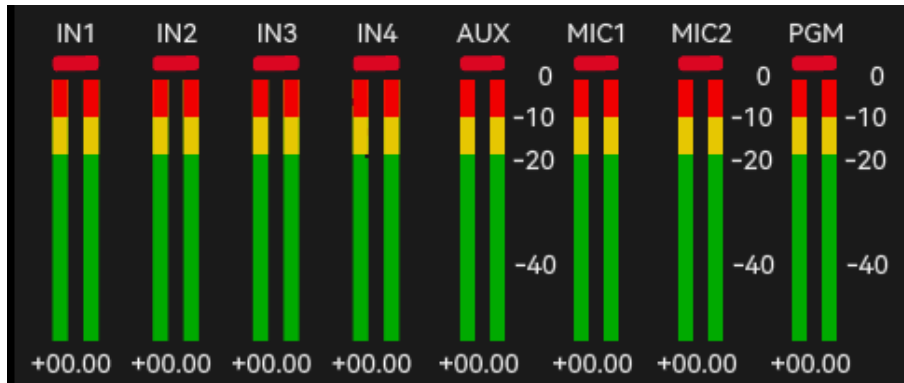

Figure 4.1-6 Audio Meter Panel

Tips

- You could check the audio information from the outputs **OUT1**, **OUT2** or **PHONE**, and assign the audio source channel to the three outputs respectively by the following menu items:
 - OUT1**: set by **Setting**→**out source**→**HDMI1** menu item.
 - OUT2**: set by **Setting**→**out source**→**HDMI2** menu item.
 - PHONE**: set by **Audio Mixer**→**monitor**→**Source** menu item.
- Refer to "5.1.11 Audio Mixer Settings" for more details about the audio channels and audio parameters settings.
- Refer to "4.1.3.18 How to Use Audio Mixer" for more details about audio mixer pane.

4.1.2.4 Macro Control

A macro is an easy way to automate a sequence of switcher actions so you can repeat the sequence at the press of a button.

For example, you can record a sequence of transitions between several video sources, including key effects, audio mixer adjustments and more to a macro button, then when you press that button all your recorded actions will be instantly performed.

The macros are stored as an XML file to your SD card.

- **MEM1~MEM8**: Up to 8 macro are provided on the panel, the buttons are as shown in Figure 4.1-7. The button without commands is in dark grey, the

button in the process of recording is in white blinking, and the button ready for performed is highlighted in white.

- **Record Macro:** press a macro button to start recording, then it will record every setting, press of a button, and switcher action you perform, press it again to finish this macro, and the macro indicator is blinking during this process.
- **Run Macro:** press a macro button to run the instructions recorded in this macro. When you run a macro, all the switcher actions you recorded in that macro will be repeated precisely.

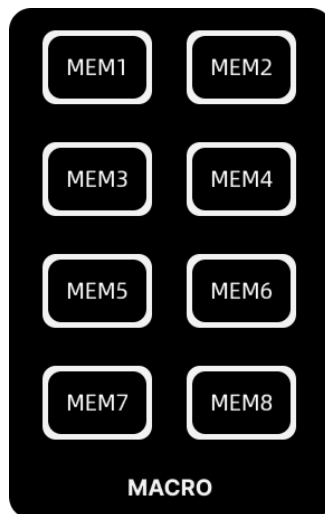

Figure 4.1-7 Macro Buttons

Tips

- Refer to "4.1.3.19 How to Record and " for more details about Macro.
- If you want to record over a previously recorded macro, you should manually clear it which is saved in a folder named **Macro** in your SD card. Then follow the recording instructions again.

4.1.2.5 Main Menu

Press **MENU** button to display the main menu to set more details for all the functions.

1. **MENU button: display the main menu**

Press the **MENU** button to display the main menu including a full list of panels for GoStream unit settings, and you can return to the upper level or exit the main

menu after that by pressing this button again.

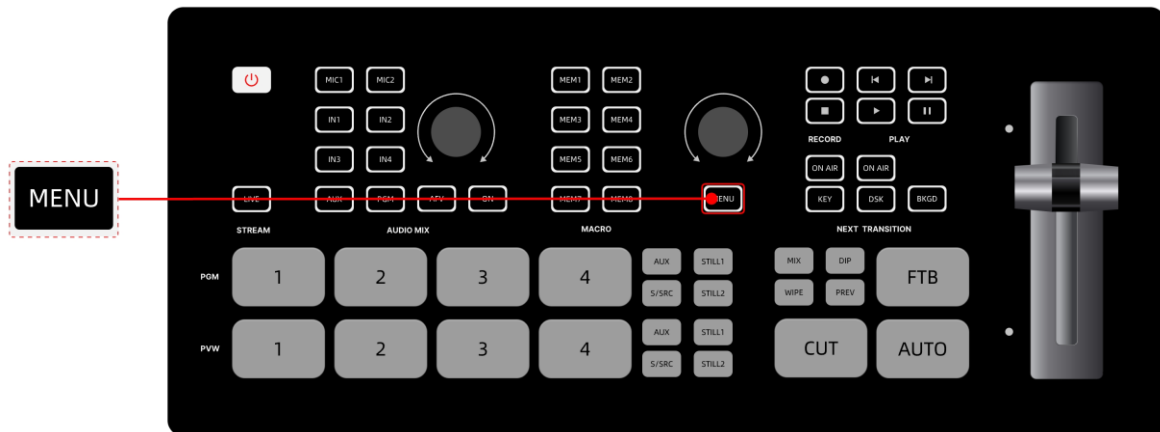

Figure 4.1-8 Menu Button

2. Knob: adjust settings

Knob is used to select a menu item, increase or decrease an item value, and confirm selection. The details are as below:

■ Item Selection

Press **MENU** button to display the main menu, scroll the knob clockwise to move the selection cursor downward along the menu list and select the next menu item, scroll the knob counterclockwise to select the previous item.

■ Value Selection

After selecting a menu item in the main list, press the knob straight down to confirm the selection, and enter the submenu list, scroll the knob clockwise or counterclockwise to select a parameter which you desire to modify its value. Press the knob straight down again to confirm the selection, then you can increase its value by scrolling clockwise, or decrease it by scrolling counterclockwise.

■ Confirm Selection

Press the knob straight down, you can enter the next level menu or confirm the value selection.

Tips

- Refer to "5.1 Main Menu" for more details about the main menu.

4.1.2.6 Recording

Use the record buttons to save stream clips to the SD card, and you can use these sources as **AUX** signal.

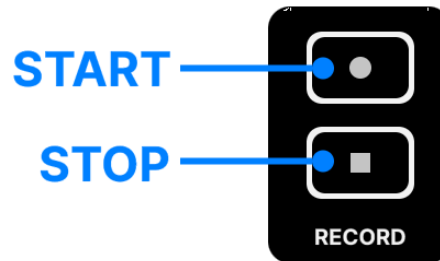

Figure 4.1-9 Record Buttons

Press **START** button to start recording, now you are recording your broadcast to disk, and the button will change from gray to highlighted red to indicate the clip is in the process of recording. Then press the **STOP** button to stop recording, and the file recorded will be saved into SD card under "Videos" folder.

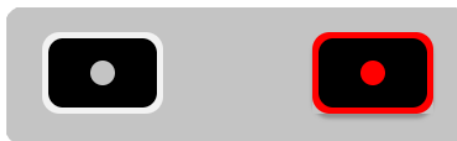

Figure 4.1-10 Colors for Record Button

Use the two buttons in record area to start or stop video recording.



Button	Comment	Description
START	Start button	Press this button to start recording
STOP	Stop button	Press this button to stop recording

Tips

- Refer to "4.1.3.21 How to Record and Play a Stream" for more details about recording settings.

4.1.2.7 PlayBack

Use the play buttons to play the media files which you have recorded or saved in SD card.

Short press the **PLAY** button  to play a clip in your SD card, the play button is highlighted in green, then click **PAUSE** button  to pause playing. And you can press the **PREV** or **NEXT** button to select the previous clip or the next one you want to show.

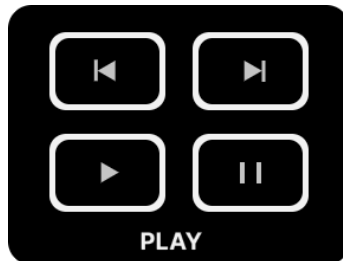

Figure 4.1-11 Play Buttons

Button	Comment	Description
PLAY	Play button	Press this button to play a video
PAUSE	PAUSE button	Press this button to pause playing
PREV	Previous Button	Play the previous clip in your media list
NEXT	Next button	Play the next clip in your media list

 **Tips**

- Refer to "4.1.3.21 How to Record and Play a Stream" for more details about UVC recording and playing.
- Long press the play button in **PLAY** area to expand a video selection list for record file selection.

4.1.2.8 Transition Control

When switching video sources, you can use a straight cut which will immediately change one source to another, or a transition which will gradually change one source to another over a defined duration. Transitions appear as an effect, and you can choose a transition style: dip, mix or wipe.

GoStream provides multiple transition modes, including cut, effect transition, FTB and manual transition. The transition area contains the following tools: a group of buttons,

including **MIX**, **DIP**, **WIPE**, **PREV**, **CUT**, **AUTO** and **FTB**, and a **T bar**, as shown in Figure 4.1-12:

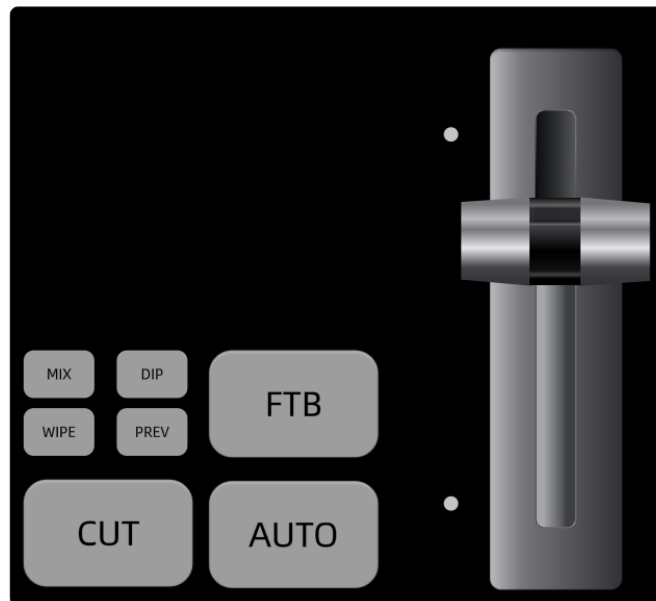

Figure 4.1-12 Transition Buttons

These buttons are mainly used as below:

Button	Comment	Description
MIX	Mix transition style	Choose mix style. A mix transition gradually fades the current source into the next until the original source is no longer visible.
DIP	Dip transition style	Choose dip style. A dip transition gradually fades the current source into the target source until the original source is no longer visible, and there is a third specify source appeared during the blending process of the original and target source. The third source which is defined as "dip source" in the dip menu could be a video signal, a color generator or internal color bar.
WIPE	Wipe style transition	Choose wipe style. A wipe transition will move a specified pattern across the original source revealing another effectively wiping across the image. Usually, the pattern could be a circle, diamond, rectangle and so on, and the pattern's border could be softened, colored and filled with a specified source.

Button	Comment	Description
AUTO	Auto Transition	Perform an auto transition. Press AUTO button to perform the selected effect transition(MIX/DIP/WIPE) of the program and preview outputs. You can see the transition process in PGM window of the multiview display.
PREV	Preview Transition	Switch to the preview transition mode, the transition simulation will be displayed in PVW window. This is very helpful for the operator to verify a mix, dip or wipe transition by performing it on the preview output, thus to avoid mistakes on air.
CUT	Cut	Perform a cut. Press CUT button to perform an immediate transition of the program and preview outputs.
FTB	Fade to Black	Perform a fading to black. The FTB button will fade the whole program video output to black, and all layers are faded down together. Once the program output has been faded to black, the FTB button will flash red until it is pressed again. Fade to black is often used at the start or end of production. The program audio will also fade with the video by enabling the AFV function.
T Bar	Manual Fader bar	Perform a manual controlled effect transition. The fader bar is used as an alternative to the AUTO button and allows the operator to manually control the effect transition with T bar. The AUTO button illuminates red for the duration of manual transition.

Tips

- Refer to "4.1.3.1 Display Multiview" for details about Multiview display.

GoStream provides the following transition modes, as shown in Figure 4.1-13:

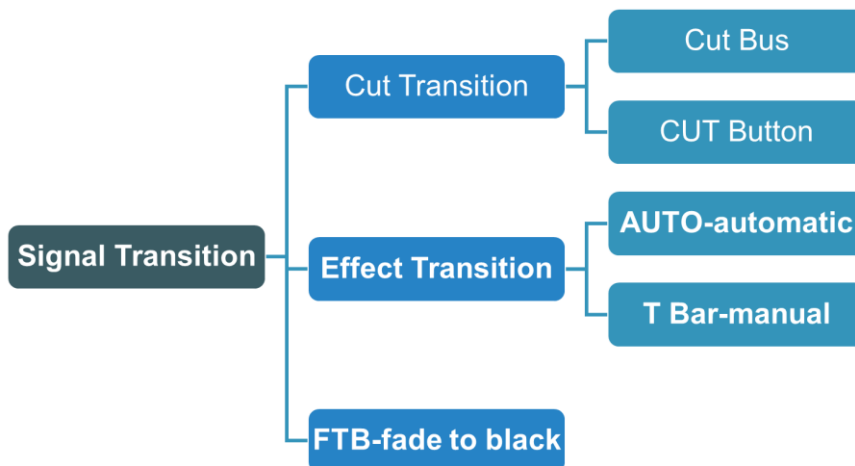

Figure 4.1-13 Transition Modes

Switching Mode:

■ **Cut Transition**

"**Cut transition**" is the basic switching mode on the switcher. In cut transition, the program output is immediately changed from one source to another. A cut transition can be performed directly from the program bus, or using the CUT button.

Cut button will let you change sources as soon as you press **CUT** button without transition effects. The upstream keyer and the downstream keyer which has been selected to output in the next transition will also change in this operation.

Besides, pressing an input button on program bus will instantly switch it to air, it is also called as cut bus, but in this way, only the background signal will be changed, but not the upstream keyer and the downstream keyer, that is the upstream keyer and the downstream keyer will maintain the status quo.

The example for cut transition: switching from current program output A to preview output B is as shown in Figure 4.1-14:

Cut Transition



Figure 4.1-14 Cut Bus- Transition from A to B

■ **Special Effects Transition**

Transitions let you smoothly switch from one source to another.

The cooperation of **AUTO** button with **MIX**, **DIP** or **WIPE** button will perform the selected effect transition at the duration specified in the 'rate' parameter.

Choose one of the three transition styles: **MIX**, **DIP** or **WIPE** by pressing any one of these three style buttons, the selected one will be indicated highlighted in white. Then press **AUTO** button, it will perform transition immediately, and the upstream keyer and the downstream keyer will take effect at once.

i Tips

- You can also choose horizontal and vertical wipe transitions, or other shapes transitions by selecting their respective transition pattern in wipe menu.
- Refer to " 5.1.8 Transition Settings" for details about more details about patterns.

You can make sense of the mix, dip and wipe transition from the illustrations in Figure 4.1-15:

mix transition (from A to B)



dip transition(from A to B, the interim is C)



wipe transition(from A to B, pattern is circle with color)



wipe transition(rom A to B, pattern is horizontal wipe)

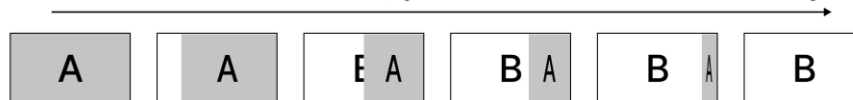

Figure 4.1-15 Transition Styles

■ **Manual Transition**

T bar is used as an alternative to the **AUTO** button and allows the operator to control the transition manually.

The **AUTO** button illuminates red during the process of the manual transition and there are two indicators beside **T bar** which are used to indicate the manual transition progress.

■ **FTB**

FTB represents fade to black transition which performs a mix to black across all video layers at the same time.

Press **FTB** button, then all video inputs, still images and any upstream or downstream keys that are visible in your broadcast will fade to black, as shown in Figure 4.1-16. The button will flash while enabled.

Fade to Black



Figure 4.1-16 *Fade to Black Illustration*

■ **Preview Transition**

The **PREV** button enables the preview transition mode, allowing the operator to verify a **MIX**, **DIP**, **WIPE** or **PIP** transition by performing it on the preview output view using the **T bar** or **AUTO** button. This is a very helpful feature to avoid mistakes on air!

Press the **PREV** button, it is highlighted in red, then you will see the preview output match the program output, practice your selected transition with the **T bar** or **AUTO** button to confirm you are going to get what you want, but the source buttons will not change during preview transition.

Tips

- The source between the original and target signal in dip transition process could be a pure color, a graph or a dynamic video set by **Transition → dip → source** item.
- Wipe transition provides up to 18 effects, including horizontal wipe, vertical wipe, circle wipe and so on, refer to " 5.1.8 Transition Settings" for the details.

Color for Transition Control Buttons:

The status for the button colors in transition area are described in the following table:

Button	Button Color		Description
	Disable	Enable	
AUTO	white	Highlighted white	Auto transition. Press this button after selecting a transition style. You can see the signal exchange both in PGM view and PVW view.
MIX	white	Highlighted white	Select one of the three styles to cooperate with AUTO button. First press style button, then press AUTO button to execute auto transition with the specified transition style.
DIP	white	Highlighted white	
WIPE	white	Highlighted white	
PREV	white	Highlighted Red	Preview transition. The transition will be performed in PVW view
CUT	white	Highlighted white	CUT transition. You can see the signal exchange both in PGM view and PVW view.
FTB	white	Red Flash	The transition will be performed in PGM view

Tips

- MIX, DIP and WIPE are mutual exclusive styles for effect transition, you can use only one at a time for AUTO transition.
- Configure your transition rate for MIX, DIP or WIPE in the corresponding items in settings of " 5.1.8 Transition Settings" menu.
- MIX, DIP or WIPE transition style is used in auto transition or manual transition.
- The CUT button performs an immediate transition of the Program and Preview outputs, regardless of the selected transition type.

4.1.2.9 Next Transition

The buttons in next transition area are used to choose the elements which will transition on air or off air with the next transition. There are upstream keyer, downstream keyer and background. The keyer can be faded on and off when the main transition occurs, or you can select just the key to transition individually.

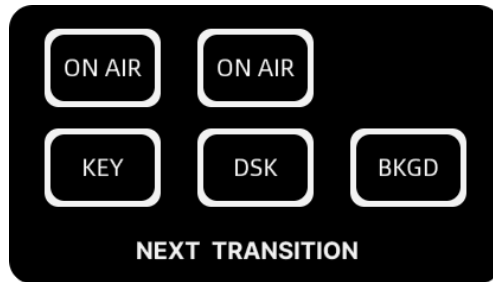

Figure 4.1-17 Next Transition Buttons

- **Upstream Keyer:** **ON AIR** and **KEY** button in first column are used to make the upstream key to be faded on or off. The **ON AIR** button in this column is corresponding to control the upstream key.
- **Downstream Keyer:** **ON AIR** and **DSK** button in second column are used to make the downstream key to be faded on or off. The **ON AIR** button in this column is corresponding to control the downstream key.
- **Background:** **BKGD** button is used to make the background signal selected on the program and preview bus to be transitioned on air or off air.

Tips

- **KEY**, **DSK** and **BKGD** indicate whether the corresponding keyer can be taken to air with the next transition or not. At least one of the three buttons should be activated at a time.
- Only the sources selected on the program and preview buses are exchanged when **BKGD** was selected with neither upstream nor downstream keyer. While you can also select only keyer to transition, leaving the current background unchanged throughout the transition.

The status of **ON AIR** for **KEY** or **DSK** will change with the transition control by using **CUT**, **AUTO** or **T bar** according to the status of **KEY** and **DSK** settings, to be on air or off air.

For example:

First, press **KEY** button to enable upstream keyer (you can see the caption is on air to the preview output, but not to the program output), then press **CUT** button to perform cut transition, **ON AIR** for **KEY** is highlighted in red, and the caption switches to the current program output. The background on the program view and preview view are exchanged because the **BKGD** was selected.

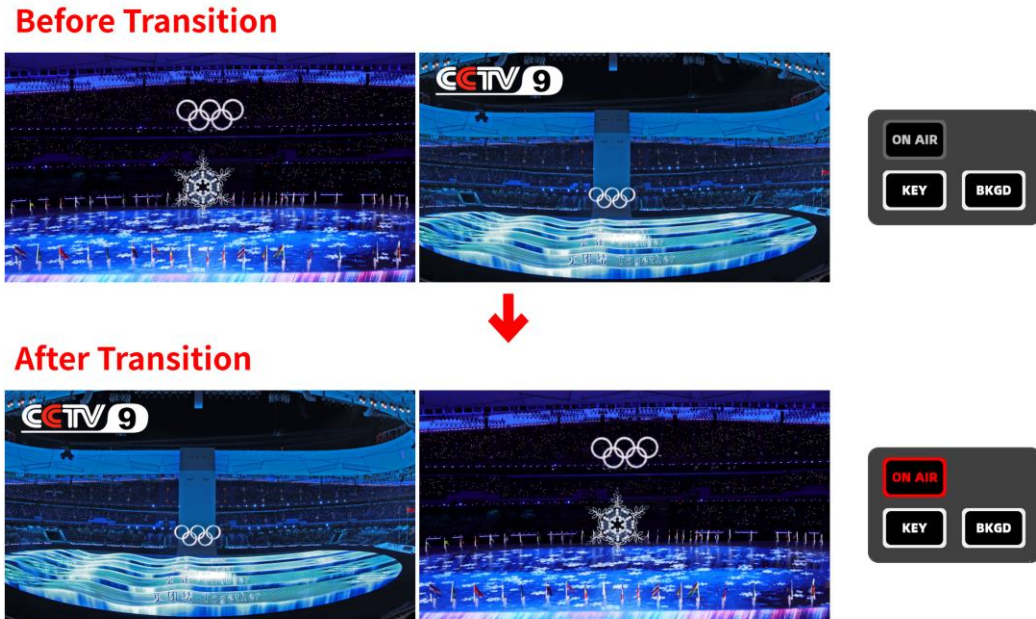

Figure 4.1-18 Next Transition Example

The final output on air is composed of upstream keyer, downstream keyer and background signal, the layer relationship of the three signals from up to down is as shown in Figure 4.1-19:

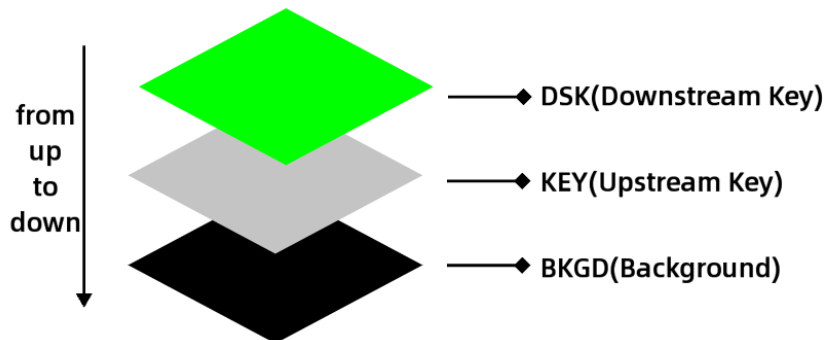

Figure 4.1-19 Output Layers Relationship

The expression for these buttons is described as in the following table:

Group	Button	Comment	Function Description
Upstream Keyer Control	ON AIR	ON AIR	<p>The ON AIR indicator button indicates when the upstream keyer is currently on air and can also be used to immediately cut the key on or off air.</p> <p>1. Press ON AIR button to enable it, the upstream keyer is immediately taken to on air, the button is highlighted in red; press this button again, the upstream keyer is directly taken to off</p>

Group	Button	Comment	Function Description
			<p>air.</p> <p>2. Execute a transition, the ON AIR indicator button indicates the upstream keyer is currently on air. (KEY is on before executing transition)</p>
	KEY	Upstream Keyer	<p>The KEY button indicates whether the upstream keyer can be taken to air with the next transition or not.</p> <p>Press KEY button, it will enable the upstream keyer to be taken to on air along with the preview output in the next transition, the button is highlighted in white; press it again to disable the upstream keyer which will not change in the next transition, the button turns in gray.</p>
Downstream Keyer Control	ON AIR	ON AIR	<p>The ON AIR indicator button indicates when the downstream keyer is currently on air and can also be used to immediately cut the key on or off air.</p> <p>1. Press ON AIR button to enable it, the downstream keyer is immediately taken to on air, the button is highlighted in red; press this button again, the downstream keyer is directly taken to off air.</p> <p>2. Execute a transition, the ON AIR indicator button indicates the downstream keyer is currently on air. (DSK is on before executing transition)</p>
	DSK	downstream Keyer	<p>The DSK button indicates whether the downstream keyer can be taken to air with the next transition or not.</p> <p>Press DSK button, the downstream keyer will be taken to on air along with the preview output in the next transition, the button is highlighted in white; press it again to disable the downstream keyer which will not change in the next transition, the button turns in gray.</p>
Background Control	BKGD	Background source	<p>The BKGD button is used to enable or disable the background signal to be transited in the next transition.</p> <p>Press BKGD, and only the BKGD button is</p>

Group	Button	Comment	Function Description
			<p>selected, a transition from the current source on the program bus to the source selected on the preview bus will occur without the keyer, and BKGD button is highlighted in white.</p> <p>Press BKGD again, only the keyer will occur in the transition, leaving the current background live throughout the transition, BKGD button turns gray.</p>

Tips

- The upstream keyer can be configured as a luma key, chroma key, pattern key or PIP key. Set the KEY type in "5.1.3Key Type" menu.
- Refer to "5.1.4 LUMA Key " for details about Luma Key parameter settings.
- Refer to "5.1.5 Chrome Key " for details about Chroma Key parameter settings.
- Refer to "5.1.6 Key Pattern " for details about Pattern Key parameter settings.
- Refer to "5.1.7 PIP " for details about PIP Key parameter settings.
- Refer to "5.1.9 DSK Settings" for details about DSK parameter settings.

Color for Next Transition Control Buttons:

The status for the button colors in Next transition area are described in the following table:

Button	Button color		Description
	Default color	Effective color	
ON AIR	White	Highlighted Red	Upstream Keyer is on air
KEY	White	Highlighted White	Upstream Keyer will change its former status in next transition
ON AIR	White	Highlighted Red	Downstream Keyer is on air
KEY	White	Highlighted White	Downstream Keyer will change its former status in next transition
BKGD	White	Highlighted White	Background will change its former status in next transition

4.1.3 Panel Operations

4.1.3.1 Display Multiview

Plug an HDMI television or monitor into your switcher's HDMI OUT2 connector so you can monitor your multiview.

Multiview features monitoring all input sources and outputs on one single screen simultaneously. This multiview is the default HDMI output source through OUT2 connector.

As shown in Figure 4.1-20, you can monitor up to 10 views, including program output, preview output, four HDMI inputs, four SDI inputs, AUX input, two still images and audio levels plus streaming status, recording time and free space in SD card. And you can load the main menu on multiview to set the specific settings for the device.

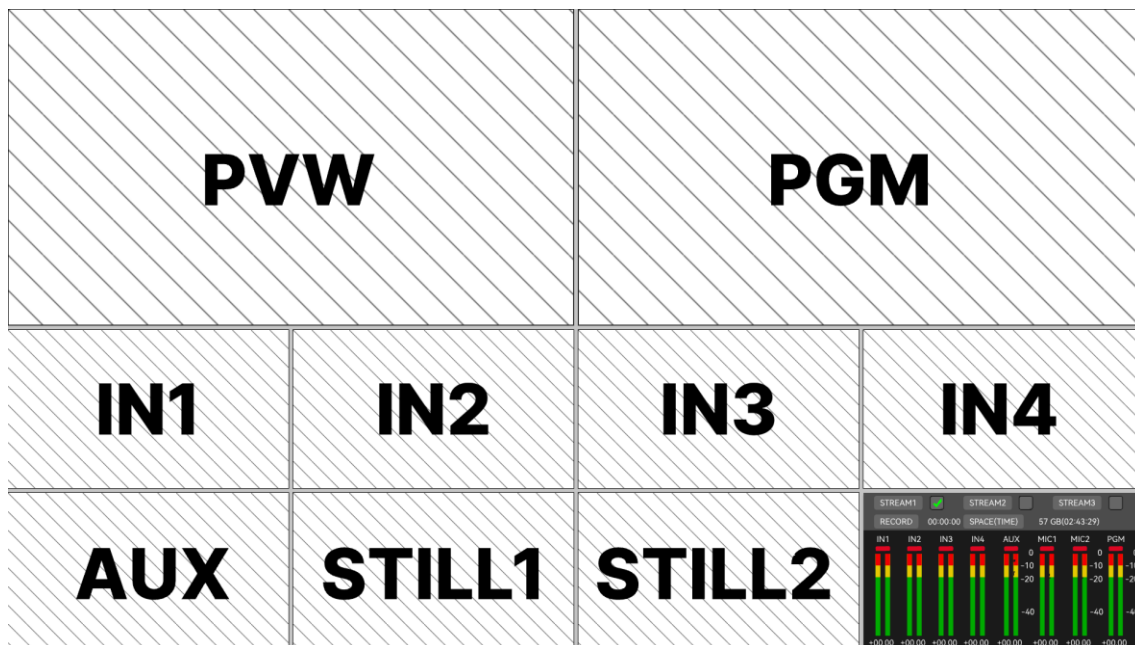

Figure 4.1-20 Multiview Display

Tips

- Multiview is the default output source for OUT2 interface and is composed of 10 views.

After connecting signals, the multiview interface is as shown in Figure 4.1-21:

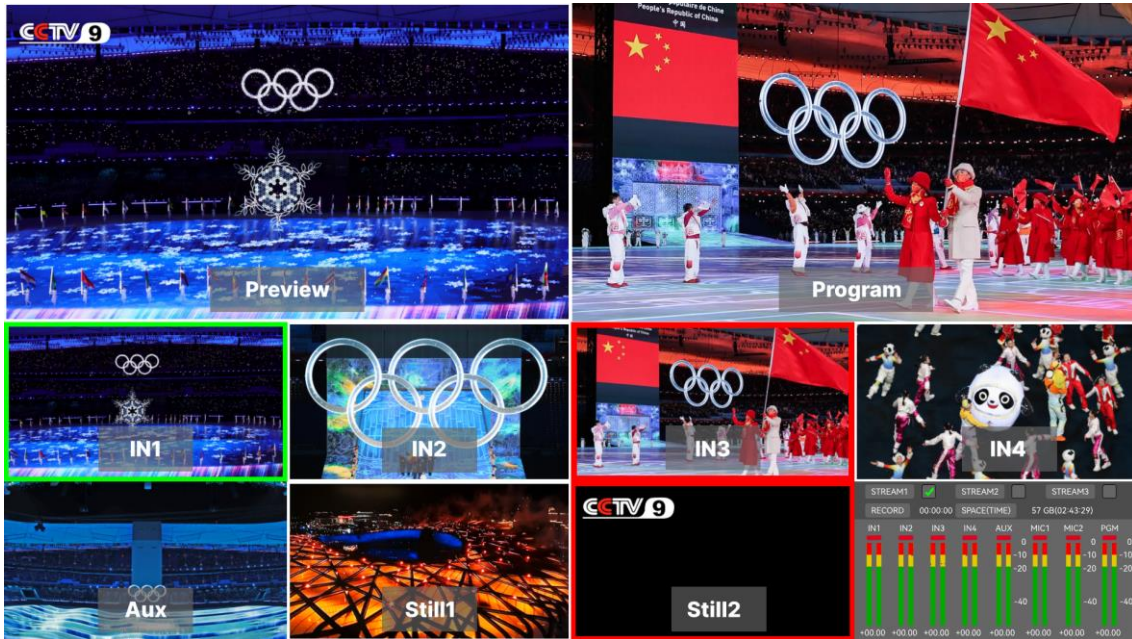

Figure 4.1-21 Multiview Display with Signals

The views of multiview are arranged in three rows, as shown in the following table:

Row No.	View Content			
Row1	Preview Output (PVW)		Program Output (PGM)	
Row2	IN1 input	IN2 input	IN3 input	IN4 input
Row3	AUX input	Still Image1	Still Image2	Audio Meter

The views indicate the status of the signals so you can easily see if they are successfully connected or displayed.

■ Program Output and Preview Output

In Row1, the left window is preview view, and the right window is program view by default.

The program view displays what is currently switched to the program output. This view will always show exactly what you are broadcasting.

The preview view displays the source currently switched to the preview output. It is helpful to practice switching between sources, previewing transitions or setting up a keyer so you can see what it will look like before switching to the program output.

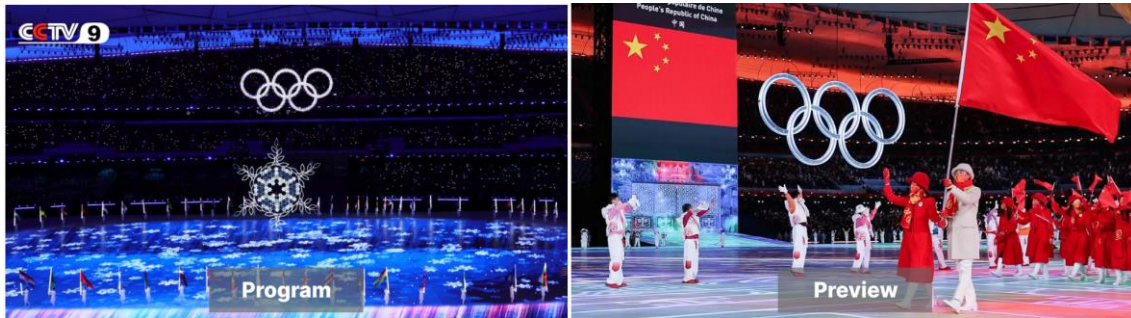

Figure 4.1-22 Program Output and Preview Output Views

■ Signal Source and Audio Meter

In Row2, the four windows are the input views which display all the sources connected to the HDMI/SDI inputs, they are arranged from left to right, including HDMI1, HDMI2, HDMI3, HDMI4, SDI1, SDI2, SDI3 and SDI4.

In Row3, the former three windows are AUX, Still1 and Still2 respectively. You can specify these three sources by menu settings. The audio meter view is displayed at the right bottom of the multiview, plus streaming status, recording time and free space in SD card.



Figure 4.1-23 Signal Sources and Audio Meter Views

■ Multiview Tally

The multiview includes a tally border feature. Any one of the sources in the multiview are used in a layer on the program output (PGM) or on air will be highlighted in red, and on the preview output (PVW) will be highlighted in green.

Tips

• Complementary for Multiview:

- Swap PGM and PVW position: swap the layout of PGM and PVW windows by setting **Setting** → **mv layout** → **PGM/PVW swap** → **PVW|PGM|PGM|PVW**.

- ❑ Still1 and Still2 view: set the still images by setting **Still Generator**→ **Still Selection**→ **Still1/ Still2**.
- ❑ AUX view: the source for AUX could be the videos from SD card, or webcam connected with USB2, choose one by setting **Setting**→**aux source**→**source** parameter.
- ❑ Audio Meter view: it provides a multiple-channel of audio level meter at the right corner of the multiview display, plus streaming status, recording time, progress of playback and free space in SD card.
- ❑ When pushing an upstream key or downstream key on air to PGM or PVW, any one of the sources in the multiview which is used as the upstream key or downstream key will be labeled as a colorful frame in the corresponding color of PGM or PVW.

4.1.3.2 Display Splicing-Super Source

Super Source function allows you to arrange two to three designated sources on one screen at one time, it appears as one single video source which can be assigned to **S/SRC** button.

■ Active Super Source

Set the menu item **Super Source** →**enable**→ **Enable** to be **On** to activate the super source function, this splicing display will be selected by S/SRC button, as shown in Figure 4.1-24:

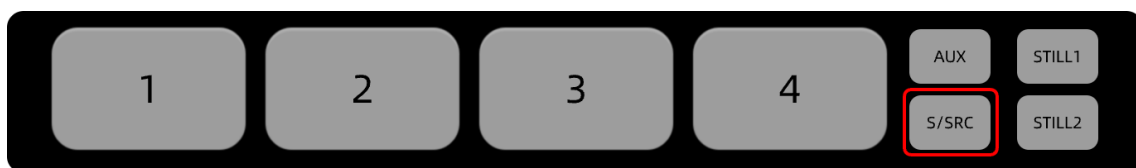

Figure 4.1-24 S/SRC button-as Supersource

■ Set Signal Sources for Splicing Display

You could assign three signal sources as super sources, two for front signals, and one for background signal. The two fronts could be superimposed onto the background one.

- ❑ **Front Source1:** select **Super Source** →**source**→ **Source1**, source1 will be spliced at the left of the splicing image;
- ❑ **Front Source2:** select **Super Source** →**source**→ **Source2**, source2 will be spliced at the right of the splicing image;

- **Background:** select **Super Source** → **source** → **Background**, background source will be spliced at the base of the splicing image.

■ **Super Source-Splicing Display Style**

Set the menu item **Super Source** → **control** → **style** to be **Crop** or **Zoom in**, you can choose the crop style or zoom in style. The video sources you selected will be arranged in different way, as shown in Figure 4.1-25

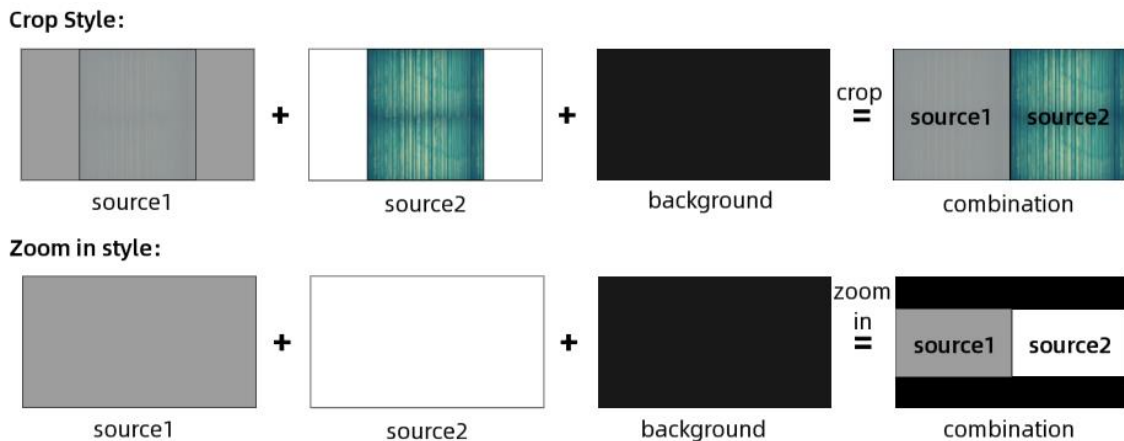

Figure 4.1-25 Splicing Styles

□ **Crop Style**

Crop **Source1** and **Source2**, take half of the two images from the center area, and splice these two areas into one combination. Unless you move or crop the splicing display, you won't see the background behind the combination.

□ **Zoom in style**

Zoom **Source1** and **Source2** out, place **Source1** as the left part of the combination, **Source2** as the right part, and **Background** as the base part behind **Source1** and **Source2**.

Tips

- The **Background's** position and size will not change with the parameters in control, mask or border field of Super Source menu.

■ **Move the Splicing Display in Vertical Direction**

You can just move the splicing display in vertical direction via **Super Source** → **control** → **Y Position** (-9.0~0) parameter. Decrease its value to move upward,

and increase its value to move downward.

Take a splicing display of zoom in style for example, move it upward or downward, the comparison is as shown in Figure 4.1-26:

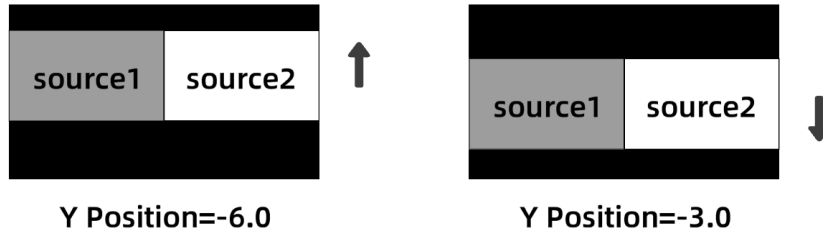

Figure 4.1-26 Move Splicing Display in Vertical Direction

■ **Crop the Splicing Display**

You can change the position and size via the **Super Source** →mask field.

First, you should set **Super Source** →mask1/mask2→ **Enable** to be **On** to allow the crop operation, then you can set the crop parameters, they are **H Start**, **V Start**, **H End** and **V End** item.

H Start and **H End** control the crop part in horizontal direction, it will crop the leftside or rightside of the combination of **Source1** and **Source2**, meanwhile, **V Start** and **V End** control the crop part in vertical direction, it will crop the upside or down side of the combination of **Source1** and **Source**. Decrease the parameters to reduce the cut part, and increase the parameters to add the cut part.

Take a splicing display of zoom in style for example, increase mask1 parameters, the changings in the splicing display are as shown in Figure 4.1-27 labeled in red arrows and dotted rectangle:

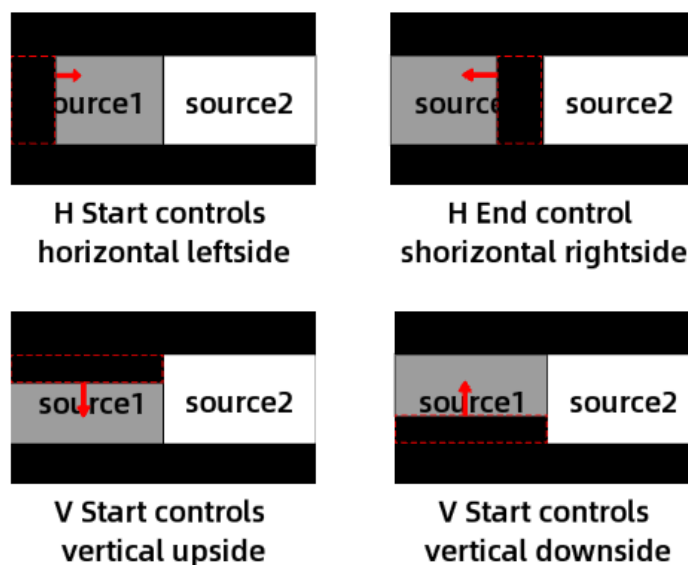

Figure 4.1-27 Crop Splicing Display Example

■ Width and Color of the Border

Add a border for **Source1** and **Source2** via **Super Source** → **border1/border2**, you can set its width and color, as shown in Figure 4.1-28:

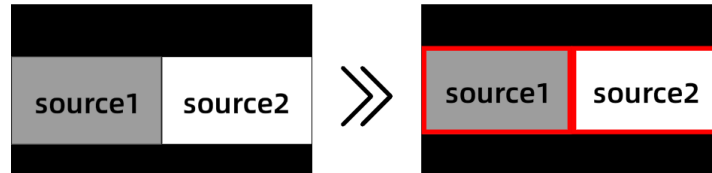

Figure 4.1-28 Border for Splicing Display

- Border Width:** Set **Super Source** → **border1/border2** → **Width** to be 0~10%, it will change the border width for **Source1** and **Source2** simultaneously;
- Border Color:** Set **Super Source** → **border1/border2** → **Hue/Saturation /Brightness** to assign a color for the border.

Tips

- Refer to "5.1.2 Super Source Settings" for details about Super Source.

4.1.3.3 Switching Sources Using a Cut

Using a cut will instantly change from one source to another, you can perform cut by switching to the target input source button on the program bus directly, or pressing the **CUT** button in transition area.

■ Cut Methods

- Method 1:** by program bus

Switching to the target input source button on the program bus directly.

On the program bus, press a program source select button, it will switch this input on air immediately.

Tips

- When using the program bus to cut, it will only change the background signal, meanwhile the upstream keyer and downstream keyer will maintain status quo.

□ **Method 2:** by CUT button

First, choose a target program source on preview bus, this will not change the current program output. Then, press the **CUT** button, it will switch the program and preview outputs immediately.

■ **Relative buttons:** **CUT** button and signal sources buttons

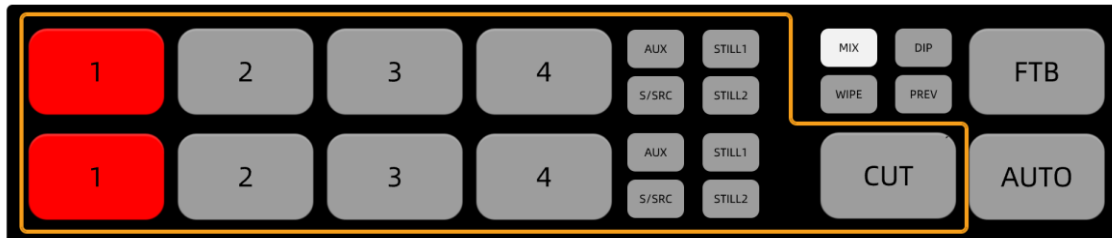

Figure 4.1-29 Buttons for Cut Operation

For example: use **CUT** button to cut from **IN1** to **IN2**. Currently, **IN1** button in program bus is highlighted in red, that is **IN1** is on air right now, and **IN4** is the preview signal which is highlighted in green in preview bus, as shown in Figure 4.1-30:

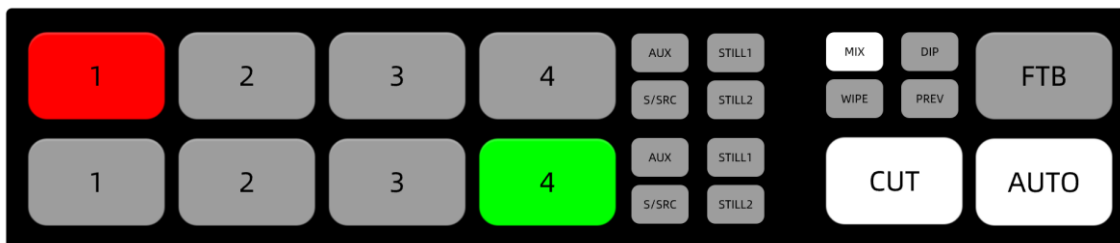

Figure 4.1-30 Bus Buttons in Default Status

Here's how to perform a cut, the instructions are as below:

Step 1 Select IN2 on preview bus

Press **IN2** on preview bus to choose **IN2** as the preview output, that you want **IN2** to be the later program output after cut transition in the future. **IN2** will change from gray to highlight green, the **CUT** button is highlighted in white by default. The current program output **IN1** will remain unchanged.

Step 2 Perform Cut

Select a cut by pressing **CUT** button, **IN1**-the current program input source and **IN2**-the target program output are all highlighted in red, and **CUT** button is highlighted in white.

Step 3 Complete Cut

After completing the cut, **IN2** on program bus and **IN1** on preview bus are exchanged, **IN2** is highlighted in red, and **IN1** is highlighted in green, **CUT** keep highlighted in white.

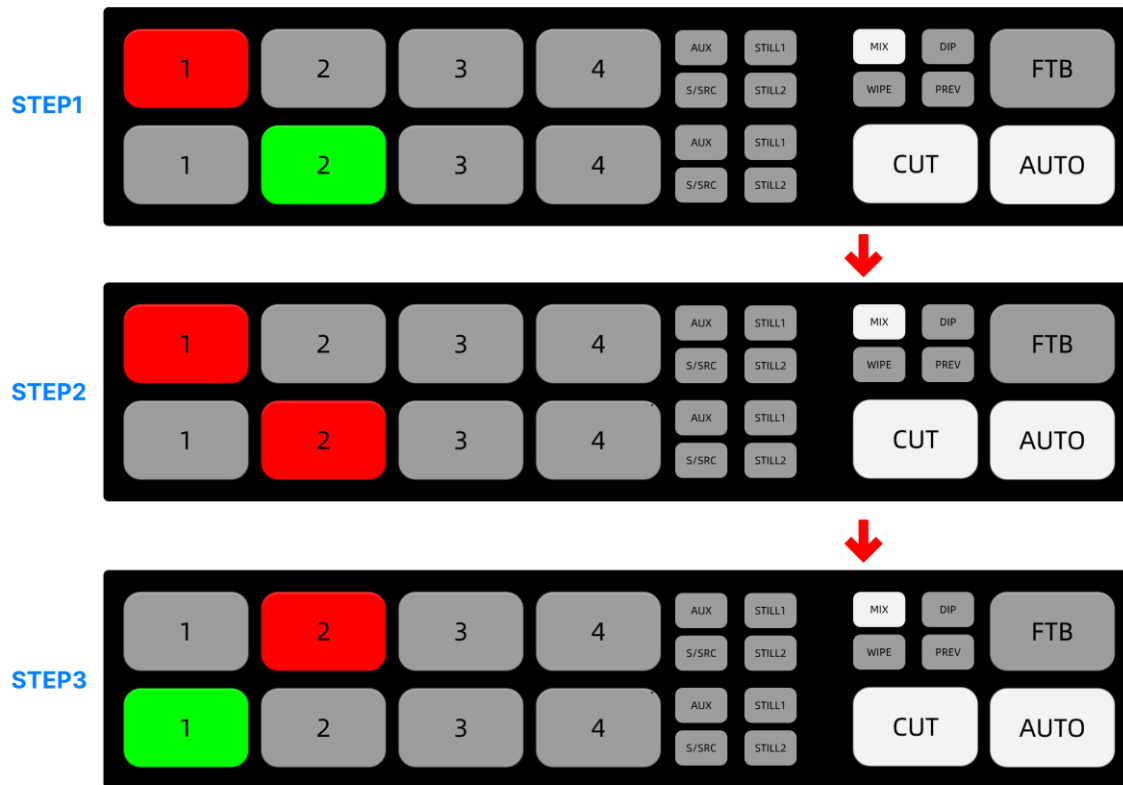

Figure 4.1-31 Cut Steps

Tips

- To secure the broadcast reliability, we recommend using the **CUT** button to perform transitions because it provides the opportunity to verify the video content on the preview output before sending it to the program output.

4.1.3.4 Switching Sources Using an Auto Transition

The **AUTO** button will perform the selected transition with a specified effect.

The transition style buttons allow the operator to choose one of three types of transitions: **MIX**, **DIP** and **WIPE**. The current selected transition style is indicated by a highlighted white button.

Press to select one of these transition style buttons and then press **AUTO** button, an effect transition will change sources over a defined duration.

- Relative buttons: **AUTO** button, signal sources and transition style buttons

i Tips

- MIX, DIP and WIPE are mutual exclusive styles for effect transition, you can use only one at a time. You can set "rate" and other parameters for different transition style, refer to "5.1.8 Transition Settings" for the details.



Figure 4.1-32 Buttons for Auto Transition

For example, use **AUTO** button to dip transition from **IN1** to **IN2**. Currently, **IN1** button in program bus is highlighted in red, that is **IN1** is on air right now, and **IN4** is the preview signal which is highlighted in green in preview bus, the default transition style is mix, as shown in Figure 4.1-33:

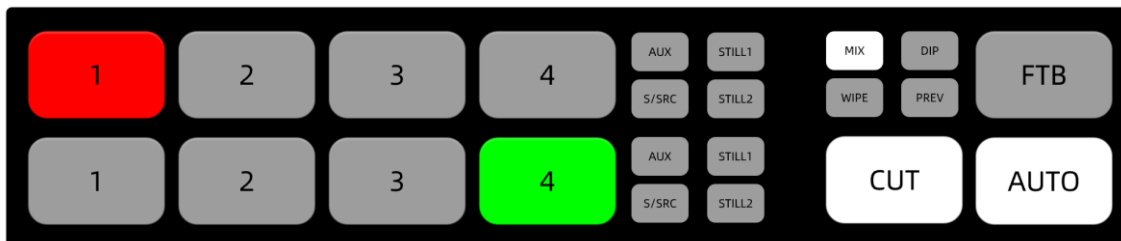

Figure 4.1-33 Buttons for Auto Transition in Default Status

Here's how to perform an auto dip transition, the instructions are as below:

Step 1 Select IN2 on preview bus

Press **IN2** on preview bus that you want **IN2** to be the program output after transition, **IN2** will change from gray to highlight green, the **AUTO** button is highlighted in white by default.

Step 2 Select a transition style and perform auto transition

Press the **DIP** button to select the dip transition style, then press the **AUTO** button to tell the switcher you want to use an automated transition. **IN1**, **IN2** and

AUTO button will be highlighted in red during transition process.

Step 3 Complete Auto Transition

After complete auto transition, **IN2** on program bus and **IN1** on preview bus are exchanged, **IN2** is highlighted in red, and **IN1** is highlighted in green, **AUTO** restores to highlight white.

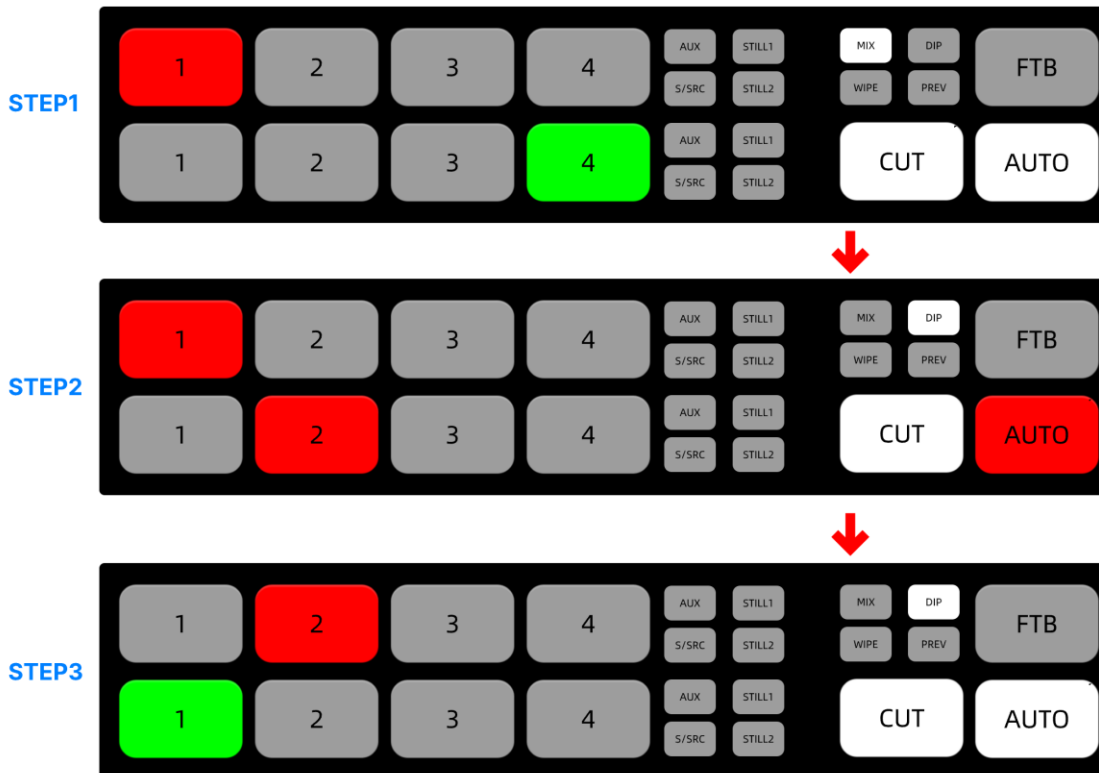

Figure 4.1-34 Auto Transition Steps

Tips

- You will see the current and target buttons and AUTO button illuminated red while you are in the middle of the transition process.

4.1.3.5 Fade to Black

FTB represents fade to black transition which performs a mix to black, and it will be happened across all video layers at the same time. When you perform a transition using the FTB button on panel, the fader indicator is flashing red on the progress of FTB transition.

Tips

- Refer to "5.1.10FTB Settings" for setting about **FTB** duration.

■ **Audio fade with Video for FTB**

Fade the audio with fade to black operation by selecting the **AFV** item in **FTB** menu.

■ **Relative buttons:** **FTB** button and signal sources buttons



Figure 4.1-35 Buttons for FTB Transition

i Tips

- Fade to black is mostly used at the start and end of your production, or when cutting to commercial breaks.
- Fade to black ensures all layers are faded down together.
- A fade to black cannot be previewed.
- You can also set the audio mixer to fade the audio with your fade to black by selecting the **AFV** item in **FTB** menu by enabling **FTB**→**audio**→**AFV** item.

4.1.3.6 Perform Manual Transition

Use T bar to perform manual transition which is as the same as an auto transition using the AUTO button.

- **Relative buttons:** T bar, signal sources and transition style buttons
- **Operation:** push T bar from one end to the other end with a manual controlled rate.

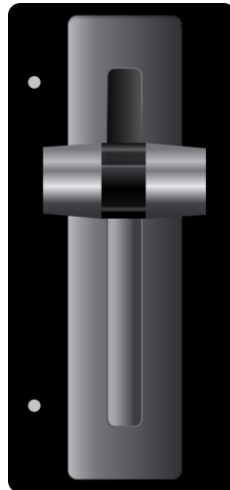

Figure 4.1-36 T Bar for Manual Transition

Tips

- The AUTO button illuminates red for the duration of manual transition, and the two indicators beside T bar also indicate the manual transition progress.

4.1.3.7 Perform Preview Transition

You can supervise the preview transition process only in preview output view of multiview, allowing the operator to verify a MIX, DIP, WIPE or PIP transition using T bar or AUTO button to avoid mistakes on air!

Press the **PREV** button, you will see the preview output match the program output in preview output view, and it is highlighted in red, then practice your selected transition with the T bar or AUTO button to confirm you are going to get what you want, but the color of source buttons will not change during preview transition.

- **Relative buttons:** **AUTO** button, **T** bar, signal sources, transition style buttons and **PREV** button.



Figure 4.1-37 Buttons for Preview Transition

i Tips

- Neither the source buttons, nor AUTO button will change during preview transition.

For example, use **AUTO** button to wipe transition from IN1 to IN2. Currently, IN1 button in program bus is highlighted in red, that is IN1 is on air right now, and IN4 is the preview signal which is highlighted in green in preview bus, the default transition style is **MIX**, as shown in Figure 4.1-33:

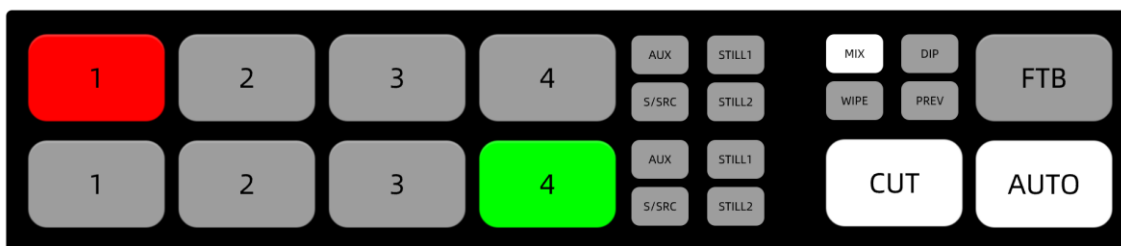

Figure 4.1-38 Buttons for Preview Transition in Default Status

Here's how to perform a wipe transition as preview transition, the instructions are as below:

Step 1 Select IN2 on preview bus

Press IN2 on preview bus that you want IN2 to be the program output after transition, IN2 will change from gray to highlight green, the **AUTO** button is highlighted in white by default.

Step 2 Enable Preview transition mode

Press the **PREV** button to activate preview transition. The **PREV** button will be highlighted in red, as shown in Figure 4.1-39, and the preview output matches the program output in preview output view, that is the picture of **IN1** will be displayed in preview output view as the same as in program output view.

Before: PREV=off



After: PREV=on



Figure 4.1-39 Enable/Disable PREV Button Before and After

Step 3 Select transition style and perform auto transition

Press the **WIPE** button to select a transition style, then press the **AUTO** button to tell the switcher you want to use an automated transition. **IN1**, **IN2** and **AUTO** buttons will keep their original status during preview transition process.

Step 4 Complete preview Transition

Supervise the preview transition process in preview output view.

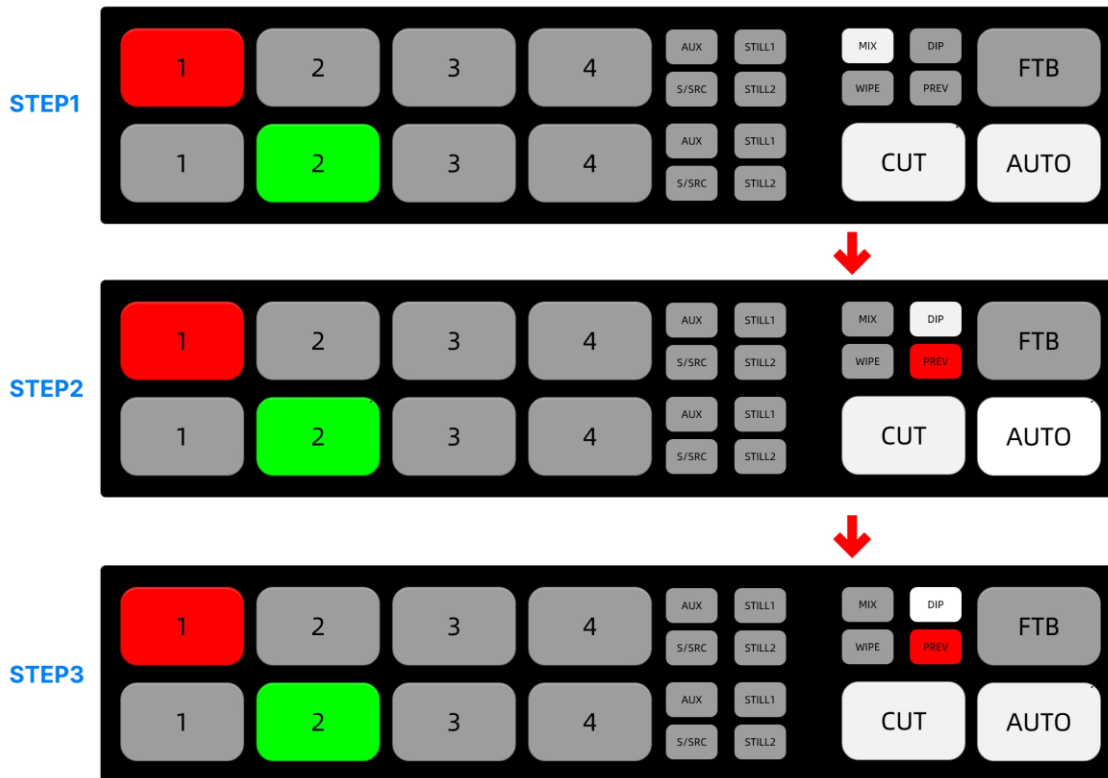

Figure 4.1-40 Preview Transition Steps

i Tips

- You can select AUTO button or T bar to practice your selected transition to confirm you are going to get what you want by preview transition. After that, release the PREV button to perform your transition on air.

4.1.3.8 Set Transition Rate and FTB Rate

Set the rate settings respectively in Transition and FTB menu so you can switch smoothly.

- **MIX:** Set **Transition**→**mix**→**Rate** item for mix transition, as shown in Figure 4.1-41;
- **DIP:** Set **Transition** →**dip**→**Rate** item for dip transition;
- **WIPE:** Set **Transition** →**wipe**→**Rate** item for wipe transition;
- **FTB:** Set **FTB**→**rate**→**Rate** item for fade to black.

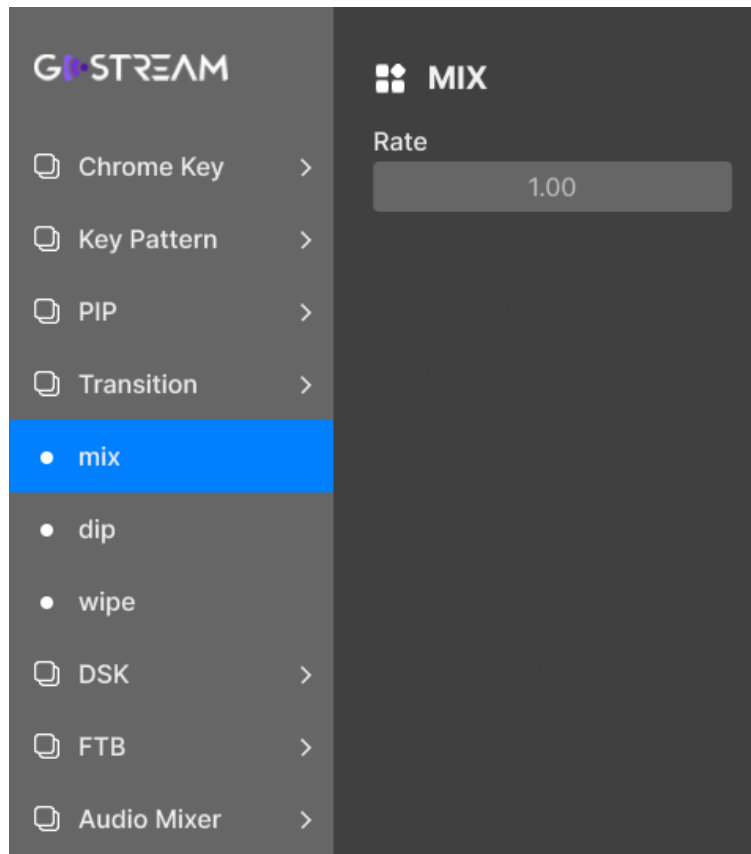

Figure 4.1-41 Transition Rate for MIX

The AUTO button is flashing in red during the automatic transition process, and the indicators for T Bar could be also highlighted to indicate the manual transition process.

4.1.3.9 Classifying- Keyer Control

Keyers are a powerful tool that arrange visual elements from different sources on the same video image. There are two types of keyers available on the switcher, upstream keyer and downstream keyer, that **KEY** button is assigned as upstream keyer, while **DSK** button is assigned as downstream keyer, as shown in Figure 4.1-43.

In keyer control, multiple layers of video or graphics are stacked on top of the background video. Altering the transparency of parts of these keyer layers allows the background layer to be visible. This process is called keying. Take downstream keyer for example, push DSK on air in next transition, the caption, Logo or other accessory images keying by DSK control will not disappear with the background exchanging.

The layers relationship from up to down is upstream keyer, downstream keyer and background source, as shown in Figure 4.1-42:

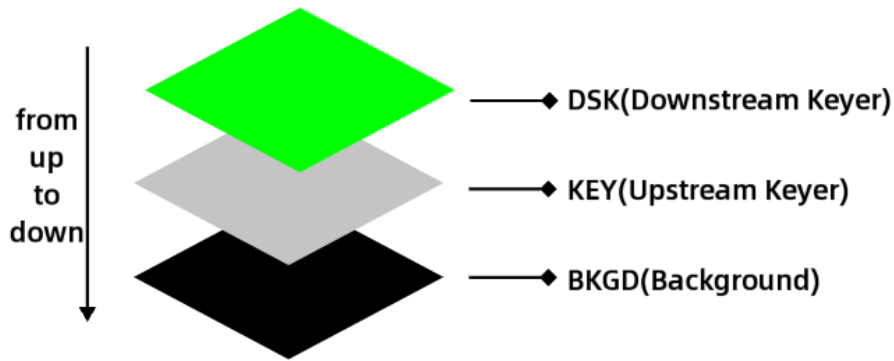

Figure 4.1-42 Position Relationship of Layers

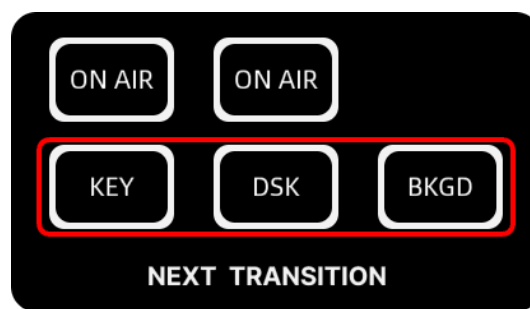

Figure 4.1-43 Keyer Buttons

Press **KEY** button on or off to switch upstream keyer on or off air in next transition, while press **DSK** button on or off to switch downstream keyer on or off air in next transition.

According to various techniques used to create selective part, it provides different types of key on the switcher, including luma, linear, chroma, pattern and PIP key. Upstream keyer can be set as luma, linear, chroma, pattern and PIP key. Downstream keyer can be set as luma or linear key, as shown in the following table:

Keyer Type	Button	Key Type	Menu
Upstream Keyer	KEY	Luma Key (or linear key)	Luma Key
		Chroma key	Chroma key
		Pattern key	Key Pattern
		PIP key	PIP
Downstream Keyer	DSK	Luma Key (or linear key)	DSK
---	BKGD	---	---

i Tips

- You can assign a type for upstream keyer by setting **Key Type**→**Type** menu item.

■ **KEYING**

Use keying techniques to get the stacked area as the operation result which will be selected as upstream keyer or downstream keyer.

A key requires two video sources: the fill signal and key signal. The fill signal contains a video image which is used to be stacked on top of the background, while the key signal is used to make the selection regions where the fill signal will be made transparent.

Both the fill signal and key signal can be selected from any of the switcher’s external inputs or internal sources, either still or dynamic images. Refer to "4.1.3.10 Set Fill Source or Key Source" for details.

Set the fill signal and key signal in the key menus, including:

- LUMA Key:** refer to "5.1.4 Luma KEY Settings";
- Chrome Key:** refer to "5.1.5 Chroma KEY Settings";
- Key Pattern:** refer to "5.1.6 Key Pattern Settings";
- PIP:** refer to "5.1.7 PIP Settings";
- DSK:** refer to "5.1.9 DSK Settings".

4.1.3.10 Set Fill Source or Key Source

You need to set source as fill source or key source for upstream key or downstream key. The source items for these keyers are different, as shown in Table 4.1-2:

Table 4.1-2 Key and Fill Source Item for Upstream or Downstream key

Keyer Type	Button	Menu	Fill Source	Key Source
Upstream Keyer	KEY	Luma Key	✓	✓
		Chroma key	✓	
		Key Pattern	✓	
		PIP	✓	
Downstream Keyer	DSK	DSK	✓	✓

Fill source is the graphic that you plan to display on top of your background video, and Key source defines the region in the image that will be removed so that the fill signal can be correctly stacked on top of the background.

The key and fill source could be selected from external inputs or internal sources. The externals refer to HDMI1~HDMI4, AUX from SD card or webcam connected with

USB2, while the internals refer to color generators, color bar and black generator.

i Tips

- Select Fill source by setting **source**→**Fill**, and Key source by setting **source**→**Key**.

The options for the key and fill source are as shown in the following table:

Table 4.1-3 Key Source and Fill Source List

Type	Item	Description	Comments
Fill/Key	IN1	HDMI1/SDI1 input	Signal from HDMI1/SDI1 connector
	IN2	HDMI2/SDI2 input	Signal from HDMI2/SDI2 connector
	IN3	HDMI3/SDI3 input	Signal from HDMI3/SDI3 connector
	IN4	HDMI4/SDI4 input	Signal from HDMI4/SDI4 connector
	AUX	Auxiliary signal	From SD card or camera connected with USB2
	STILL1	Still image 1	Select by menu setting Still Generator→Still Selection→ still1
	STILL1 KEY	Grayscale Still1	A grayscale image of still1
	STILL2	Still image 2	Select by menu setting Still Generator→Still Selection→ still2
	STILL2 KEY	Grayscale Still2	A grayscale image of still2
	Color1	Color generator 1	Set by Color back→color1
	Color2	Color generator 2	Set by Color back→color2
	Color Bar	Color bar	Internal signal
	BLACK	Black signal	Internal signal

i Tips

- Select AUX source by setting the **Setting**→**src selection**→**Aux** menu item.
 - Sd Card: videos or images stored in SD card.
 - Usb Camera: camera connected with USB2.
- When pushing an upstream key or downstream key on air to PGM or PVW, any

one of the sources in the multiview which is used as the upstream key or downstream key will be labeled as a colorful frame in the corresponding color of PGM or PVW.

4.1.3.11 Set Luma Key or Linear key

A luma key and Linear key are consisted of the same two video sources, and they are all set their parameters by LUMA Key menu.

Here, the fill source and key source are same for luma key, but the fill source and key source are different for linear key. The differences for luma key and linear key are described as below.

■ Luma Key

A luma key is also called as self-key, it consists of one video source, that is, the fill source and key source are the same one. Luma key contains the video image that will be stacked on top of the background, that is, all the black areas defined by the fill source will be made transparent so that the background source can be revealed underneath.

The following images are an example of what background, luma key signals and the resulting combined image might look like, as shown in Figure 4.1-44.



Figure 4.1-44 Luma Key Illustration

The above example is illustrated as below:

- **Background Source:** A full screen image, the program output source in the switcher, here is a landscape of the Great Wall;
- **Fill Source/Key Source:** they are the same for luma key, the black area will be made transparent to reveal the background.

Tips

- The background used in the illustrations in the following sections is also directed to

the program output source, and the combined is the result of background and keyer. No further description below.

■ **Linear Key**

A linear key consists of two video sources, which are the fill source and key source. The fill source contains the video image that will be stacked on top of the background, and the key source defines the black areas where will be made transparent so that the background source can be revealed underneath.

The following images are an example of what background, linera key signals and the resulting combined image might look like, as shown in Figure 4.1-45:

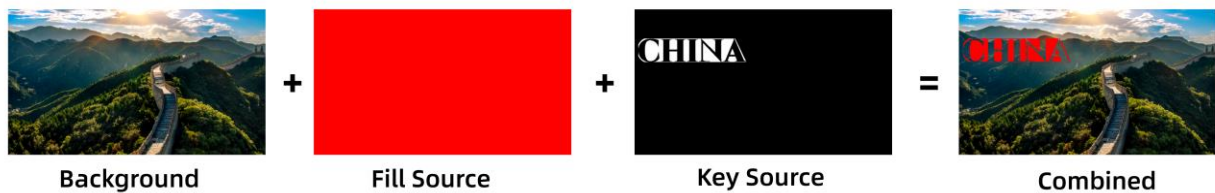

Figure 4.1-45 Linear Key Illustration

Here's how to generate the above linear key:

- **Background Source:** a full screen image, the program output source in the switcher, here is a landscape of the Great Wall;
- **Fill Source:** the image to be stacked on top of your background video, and the selection area is defined by key source;
- **Key Source:** the area defined in black which is set as key source will be removed from the fill source, and the left area of fill source will leave as the stacked part on top of background.

i Tips

- Select fill source and key source for luma key by setting **Luma Key →Source** menu item, and adjust the mask area by **Luma Key→Mask**, adjust the Pre multiplied Key parameters by **Luma Key→Control**. Refer to "5.1.4 LUMA Key" for the details about luma key parameters.

4.1.3.12 Set Chroma Key

Chroma key usually selects a specified color sampled in the fill source to form a selection area which will be removed, and you can see the black area of the chroma key is the keying result, as shown in the following illustration. The background signal in range of this selection will be visible. This is often used as green screen matting.

The default sample color of the switcher is green (0,255,0)(RGB) which is often used for chroma key. You can enable a sample cursor to define a customized sample color by setting **Sample**, **SMP X Position** and **SMP Y** in **Chroma Key**→**Control** submenu.

To refine the selection, use the parameters in **Chroma Key**→**Control** menu to set **Foreground**, **Background** and **KeyEdge** to make the selection more qualified and cleanly.

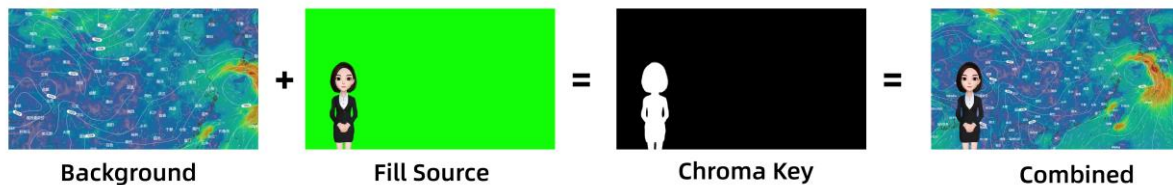

Figure 4.1-46 Chroma Key Illustration

Here's how to generate the above chroma key:

- **Background Source:** a full screen image, the program output source in the switcher, here is a weather map;
- **Fill Source:** the image to be displayed on top of your background video, and in the case of a chroma key, this is video of the meteorologist in front of the green screen; set the fill source by **Chroma Key**→**source** →**Fill** item, and you can sample a color to be removed from the fill source by **Chroma Key**→**Control** settings.
- **Chroma Key:** the area defined in black is generated from the settings of **Fill** and **Control** items, and this black area will be removed from the fill source, and the left area of fill source will leave stacked on top of background.

Step 1 Assign Chroma Key to KEY button as upstream key

The chroma key belongs to the upstream key, so set it as "Chroma Key" through the "Key Type" menu.

Press MENU button to display the menu panel, then scroll the knob above the MENU button, move the cursor to the menu item to "Key Type" and then set "Key Type→ Type" item to "Chroma Key". Press the knob downward to confirm the selection, then scroll the knob to the left to quit the main menu.

Step 2 Set Chroma Key Parameters

When the cursor is on the main menu list, scroll the knob to the right to move the cursor downward to the "Chrome Key" menu item. Press the knob downward to confirm the selection, and enter the chrome key menu panel, continue to operate with the knob to set various chrome parameters with "Source, Mask, Resize and Control" options. Eg: the fill signal, color sampling, the display range and relative size controller parameters.

Step 3 Activate Chrome Key

Press the ON AIR button above the KEY button to activate the chrome key function, superimpose it onto the current PGM screen.

Tips

- Select fill source for chroma key by setting **Chroma Key → Source → Fill Source**, and to refine the selection area for chroma key **Chroma Key → Control** menu item. Refer to "5.1.5 Chrome Key " for the details about chroma key parameters.
 - When sampling on screen, we recommend sampling the darkest area first to give you a more accurate key.
 - **About sample color:** When sampling on screen, you should set **Chroma Key → control → Sample** as **Enable**. After getting your sample color, make sure you will set **Chroma Key → control → Sample** as **Disable** to shut down the color sampling in order to close the sample image which is on the top layer.
-

4.1.3.13 Set Pattern Key

A pattern key is used to display a geometric cut out of one image on top of another image. In a pattern key, the key or cut signal is generated using the switcher's internal pattern generator. The internal pattern generator can create 18 shapes that can be sized and positioned to produce the desired key signal.

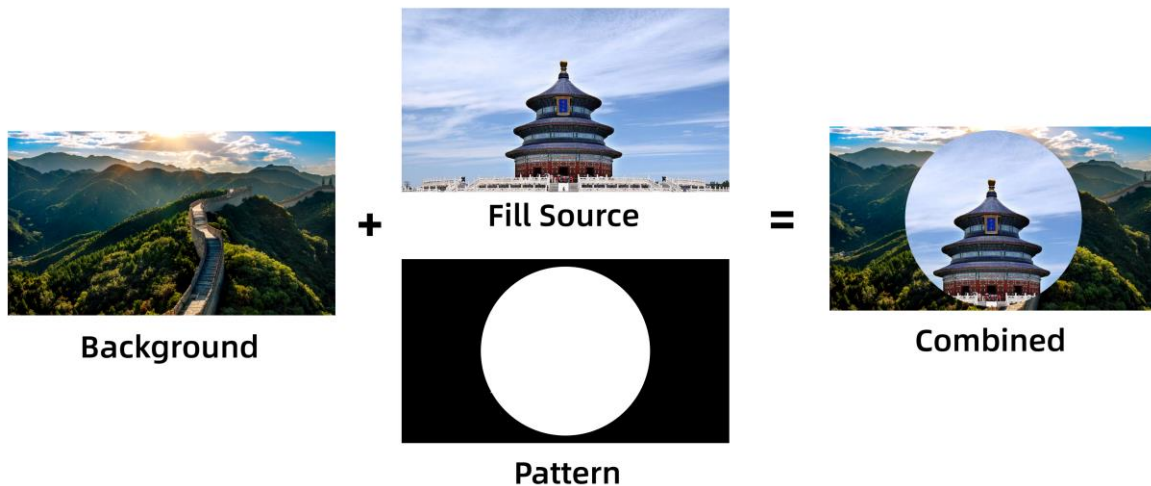

Figure 4.1-47 Pattern Transition Illustration

Here's how to generate a circle pattern key:

- **Background Source:** a full screen image, the program output source in the switcher;
- **Fill Source:** another full screen image you wish to overlay on top of the background;
- **Pattern:** an internal pattern generator, set it as a circle;

The area of fill source defined in black by the selected internal pattern will be removed from the fill source, and the left area of fill source will leave stacked on top of background.

As shown in Table 4.1-4, you can choose various transition patterns:

Table 4.1-4 Transition Patterns

Icon	Description	Icon	Description
	Horizontal Wipe-left to right		Rectangle Wipe-from top right
	Vertical Wipe-up to down		Rectangle Wipe-from bottom right
	Horizontal Wipe- right to left		Rectangle Wipe-from bottom left

Icon	Description	Icon	Description
	Vertical Wipe- down to up		Rectangle Wipe-from top center
	Surround Wipe		Rectangle Wipe-from right center
	Rectangle Wipe		Rectangle Wipe-from bottom center
	Diamond Wipe		Rectangle Wipe-from left center
	Circle Wipe		Diagonal Wipe
	Rectangle Wipe-from top left		Diagonal Wipe

i Tips

- We recommend that adjust a low softness before setting the size for the pattern, in order to see a clear edge of the selected pattern shape.
- Refer to "5.1.6 Key Pattern Settings" for details about **Key Pattern** settings.

4.1.3.14 Set PIP Key

Picture in picture, usually called PIP, superimposes a second source over your background video source in a small frame you can position and customize. As shown in Figure 4.1-48, for example, you will see the picture in picture source appear on the screen.



Figure 4.1-48 PIP Keyer

- Set Key button as PIP: set **Key Type** → **type** as PIP.
- Set signal source for PIP: select **PIP** → **source** → **PIP** item.
- Set frame size of PIP: select **PIP** → **size/position** → **PIP size** item.
- Set frame position of PIP: select **PIP** → **size/position** → **X Position/Y Position** item.
- Set frame width of PIP: select **PIP** → **border** → **Width** item.
- Set frame color: select **PIP** → **color** → **Hue/Saturation/Brightness** items.

Here's how to generate the above PIP key:

Step 1 Set the type of upstream keyer as PIP

Press MENU to display the main menu, and scroll the menu knob to select **Key Type** → **type** → **Type** as **PIP**, KEY button will be assigned as PIP.

Step 2 Load PIP on air

Press **KEY** button to enable PIP on the preview output.

Step 3 Set PIP Source

Then set PIP source. Press MENU to display the main menu, and scroll the menu knob to select **PIP** → **source** → **PIP** as **In 1, In 2, etc.**

Step 4 Set PIP Parameters

To refine the PIP key, adjust parameters for PIP, such as position, size, mask settings, border color, etc.

Tips

- Refer to "5.1.7 PIP Settings" for more details about PIP parameters.

4.1.3.15 Set and Adjust Mask

Masking can be used as a creative setting to build rectangular cut outs on screen. Luma Key, linear key, Chroma key, Pattern key and PIP key menus all have a mask setting that can be used to crop edges in the designed video signal. The mask submenu consists of left, right, top and bottom crop controls. Refer to the corresponding menu settings for more details about mask parameters.

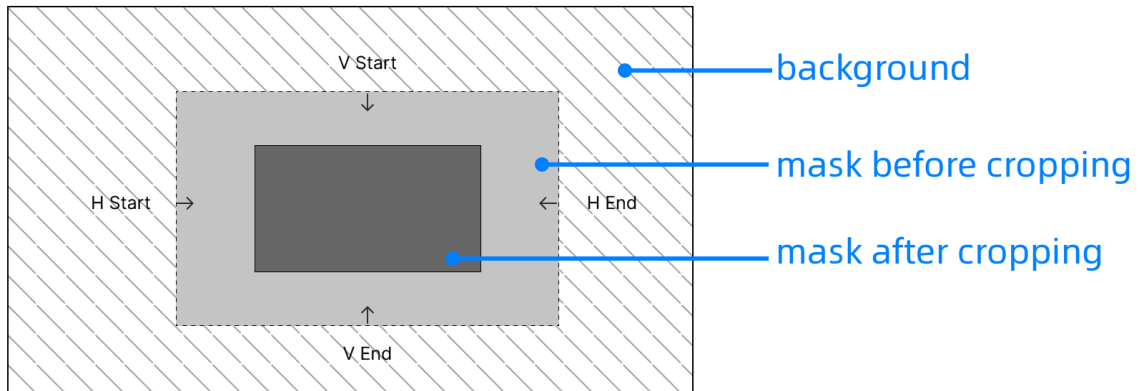

Figure 4.1-49 Cropping Mask

i Tips

- Both upstream and downstream keys have an adjustable rectangular mask.

4.1.3.16 Perform Upstream/Downstream key Transition

The upstream key is taken on and off the program output using the next transition control. So is downstream key.

KEY button is assigned as upstream key, while DSK button is assigned as downstream key, the two buttons are on the next transition area, as shown in Figure 4.1-50.

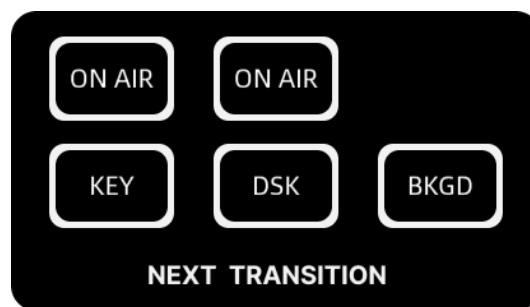

Figure 4.1-50 Next Transition Buttons

■ **KEY button**

□ **Set the upstream key type**

You can assign a type for upstream key by setting **Key Type**→**Type** menu item to the following four types, as shown in the table below:

Key Type	Comment	Key Type	Comment
Luma key	Luma Key (or linear key)	Pattern	Pattern key
Chroma key	Chroma key	PIP	PIP key

□ Perform upstream key transition

You can perform upstream key transition by ON AIR button or KEY button, as shown in labeled in red rectangle:

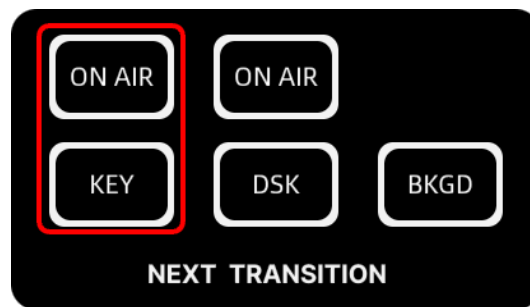

Figure 4.1-51 Upstream Key Transition Buttons

The upstream key controlled by **KEY** button will be taken on air or off air to the program output in the next transition, while controlled by **ON AIR** button is taken on air to the current program output once you activate **ON AIR** button.

Press **KEY** button, the **KEY** button is highlighted in white, the upstream key is taken on air to the current preview output but not to the current program output, so you can view it in the preview view of the multiview. Then, the upstream key will be taken on air to the program output and off air to the preview output in the next transition after executing a signal transition.

After that, press **KEY** button again to cancel the upstream key changing in the next transition, the **KEY** button turns gray.

Tips

- There are multiple ways to transition a key to the program output. The key can be cut on or off immediately or in the next transition. Use **ON AIR** button to immediately cut the key on or off air to the current program output. Use **KEY** or **DSK** button to cut the key on or off air to the program output in the next transition controls.

Upstream Key Examples

For example, take upstream key for example, use **KEY** and **CUT** button to observe the changes of upstream key in PGM and PVW views(BKGD is selected in the examples).

Here's how to perform upstream key transition:

□ Example 1

Push the upstream key on air to the program output, and cut it off air to the program output in the next transition. The process is shown in Figure 4.1-52.

Step 1 Push upstream key on air to the program output

Press **ON AIR** button of the upstream key, you will see the upstream key is on air both in program output and preview output;

ON AIR button is highlighted in red, and **KEY** button is gray.

Step 2 Change upstream key status in the next transition

Then, press **KEY** button of the upstream key, therefore the status of the upstream key will be off air in the next transition, that is opposite to the current status. And here you can see it off air in the current preview output, but still on air in the current program output;

ON AIR button is highlighted in red, and **KEY** button is highlighted in white.

Step 3 Perform cut transition

Press **CUT** button in the transition area to perform cut transition. First, the background signal on program bus and on preview bus are exchanged. Second, the upstream key is off air in current program output and on air in the preview output;

ON AIR button is highlighted in red, and **KEY** button is highlighted in white.

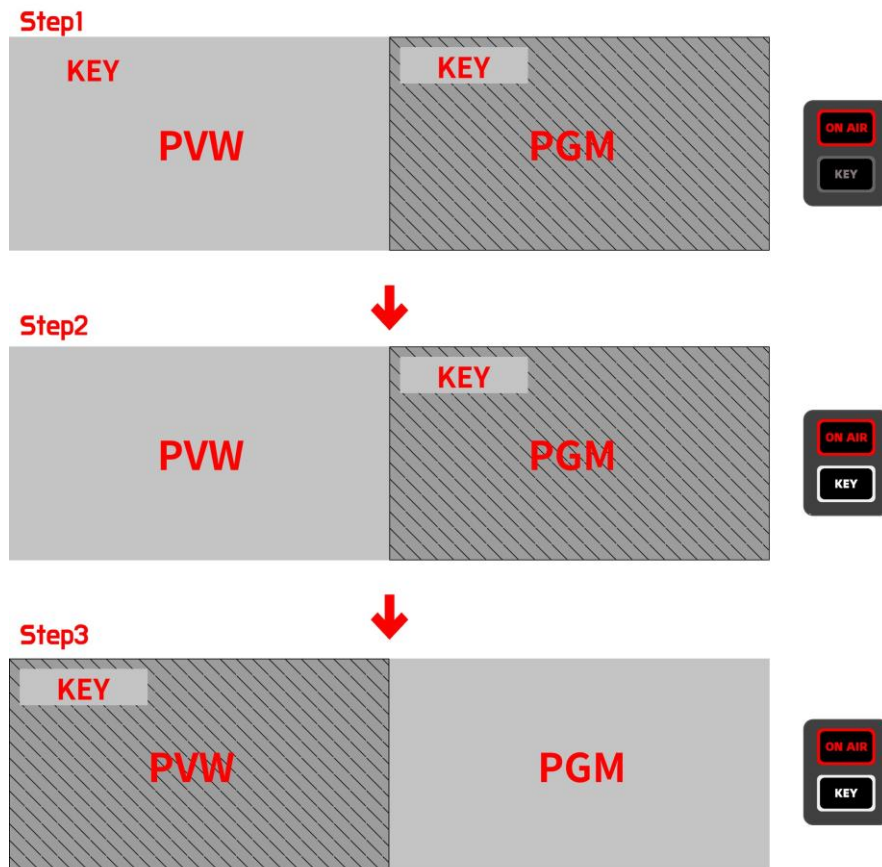

Figure 4.1-52 Before and After Upstream Key Transition-Example 1

□ Example 2

The upstream key is off air initially. Use **KEY** button to cut it on air to the program output in the next transition. The process is shown in Figure 4.1-53.

Step 1 Upstream key is off air both in program output and preview output

The initial status of upstream key is off air both in program output and preview output. You can see the **ON AIR** and **KEY** button are all gray.

Step 2 Change upstream key status in the next transition

Press **KEY** button of the upstream key, therefore the status of the upstream key will be on air in the next transition. And here you can see it on air in the current program output;

ON AIR button is still in gray, and **KEY** button is highlighted in white.

Step 3 Perform cut transition

Press **CUT** button in the transition area to perform cut transition. First, the background signal on program bus and on preview bus are exchanged. Second, the upstream key is on air in current program output and off air in

the preview output;

ON AIR button is highlighted in red automatically, and **KEY** button is highlighted in white.

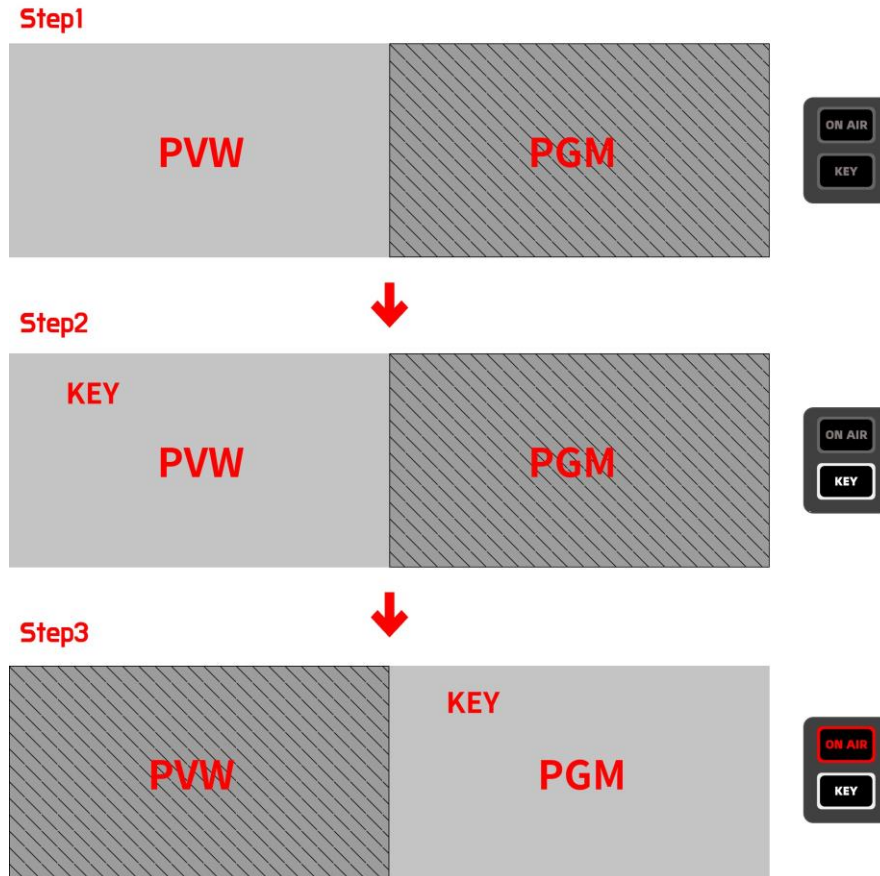

Figure 4.1-53 Before and After Upstream Key Transition-Example2

■ **DSK button**

You can perform downstream key transition by ON AIR button or KEY button, as shown in labeled in red rectangle.

The downstream key controlled by **KEY** button will be taken on air or off air to the program output in the next transition, while controlled by **ON AIR** button is taken on air to the current program output once you activate **ON AIR** button.

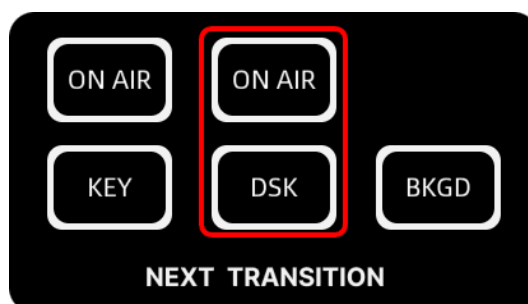

Figure 4.1-54 Downstream Key Transition Buttons

Tips

- The operations for the downstream key and background are almost the same as upstream key's, no further description here.

■ ON AIR button

ON AIR button is used as an indicator or on/off air execution button.

1. Press **ON AIR** button to enable it directly, the upstream/downstream keyer is immediately taken to on air, the button is highlighted in red; press this button again, the upstream/downstream keyer is directly taken to off air.
2. After executing a transition, the **ON AIR** indicator button indicates the upstream/downstream keyer is currently on air.

□ Example 3

Use **ON AIR** button of the upstream key to take upstream key on air or off air. (**KEY** button is not used, in gray by default). The process is shown in Figure 4.1-55.

Press **ON AIR** button of the upstream key, you will see the upstream key is on air both in program output and preview output. **ON AIR** button is highlighted in red, and **KEY** button is gray.

Press **ON AIR** button again, you will see the upstream key is off air both in program output and preview output. **ON AIR** button is highlighted in gray, and **KEY** button is gray.

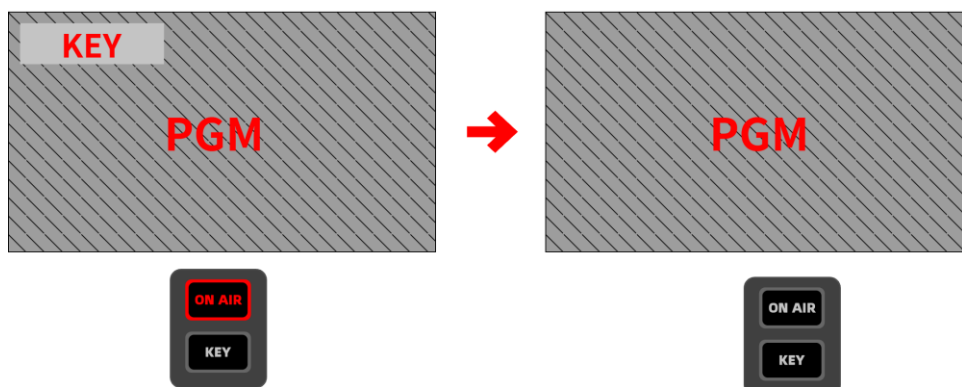

Figure 4.1-55 Before and After Upstream Key Transition-Example3

i Tips

- Each ON AIR button is corresponding to the keyer button in the same vertical column.
- Refer to "5.1.4 LUMA Key " for details about Luma Key parameter settings.
- Refer to "5.1.5 Chrome Key " for details about Chroma Key parameter settings.
- Refer to "5.1.6 Key Pattern " for details about Pattern Key parameter settings.
- Refer to "5.1.7 PIP " for details about PIP Key parameter settings.

4.1.3.17 Applying Audio Meter

GoStream provides a multiple-channel of audio level meter at the bottom right corner of the multiview display. It includes the audio level meter for HDMI1, HDMI2, HDMI3, HDMI4, AUX, MIC1, MIC2 and PGM. You can monitor the audio inputs and the program output all simultaneously.

1. Audio Meter

The audio meter is an important tool to monitor your levels for each source so you can make sure your audio always sounds great. Available or not, you can adjust each channel by the audio knobs in Audio Mixer area or settings in Audio Mixer menu.

For example: to turn on IN1 into the audio mixer, set **audio mixer** → **in1** → **Enable** as **On**, or you can press IN1 button in Audio Mixer area and then press ON button as well.

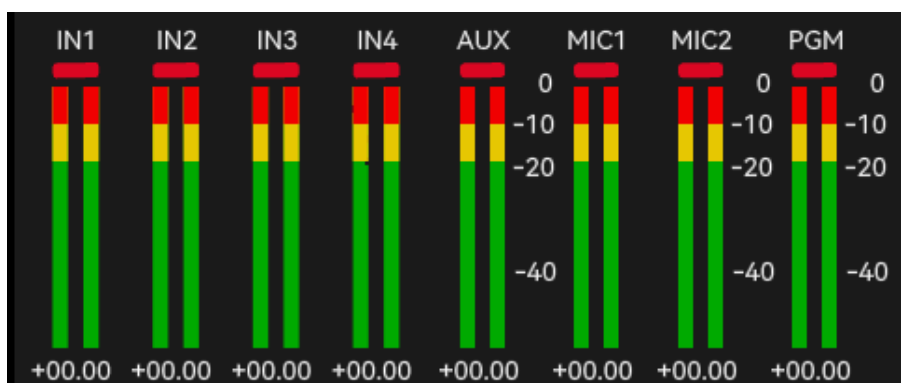

Figure 4.1-56 Audio Meter Area

2. Set MIC input Type

Set the mic input type to **Mic**, **Mic+power** or **Line** level audio.

Set the MIC input type by selecting **Settings**→*mic input→ **Mic 1 Input/ Mic 2 Input** items, as shown in Figure 4.1-57.

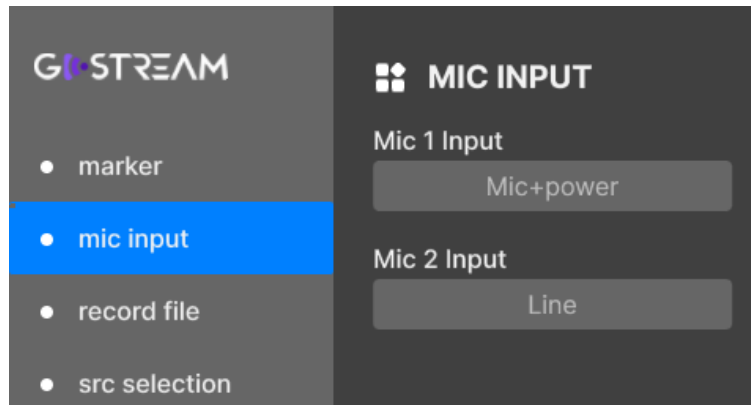

Figure 4.1-57 Mic Type Setting

Microphones typically have weaker signals compared to line type from other audio devices. This means when mic (or mic+power) is selected, the input will be boosted slightly to compensate. This also means that if mic is accidentally selected when a line level input is plugged in, the audio will sound unusually loud. If the audio sounds much louder than it should be, check that line is selected instead of mic.

Tips

- Refer to "5.1.16 System Settings" for more details about the mic input settings.

3. Set Audio Input Level

Set the audio level fader to set the gain on the audio level for each audio source in case of audio distortion.

A green number represents low to medium audio level, and the red number represents high close to maximum 0dB. Once the level reaches 0dB, the audio will clip. Clipping means the audio will distort, thus you should reduce the audio level to avoid audio distortion.

Set it by selecting **Audio Mixer**→*audio channel→**Input**.

4. Tally Indicator

The audio tally indicators are displayed as little rectangles at the top of each audio level bar, as shown in Figure 4.1-58.

The audio tally light will be lit in red when the Enable item of the audio channel is set to ON. Then if the corresponding video is the program and its AFV is set to

ON, the tally light will highlight in green.

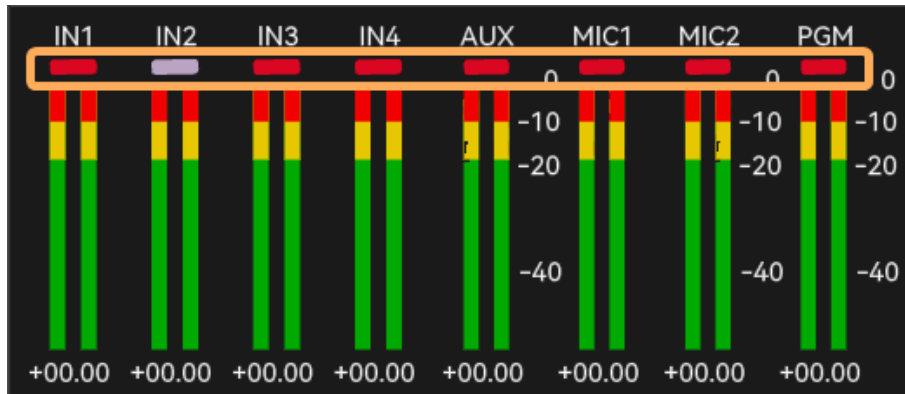

Figure 4.1-58 Tally for Each Audio Source

Tally Color	Comment	Status of button or menu
Gray	Audio source is not used, and neither of its ON or AFV buttons are enabled.	ON button is off Or menu item Enable=off
Red	Audio source is currently on air, the audio channel's Enable item is set to ON.	ON button is on Or menu item Enable=on
Green	AFV is selected, and its video corresponding to this audio channel is currently program.	AFV=ON Or Enable = AFV

For example: The audio meter for In2 is shown in gray to indicate that its audio will not be used, as neither of its ON or AFV buttons are enabled.

i Tips

- MIC1 and MIC2 have no AFV function.
- You can adjust the audio level by the audio knob in AUDIO MIX area, or set the audio menu item.
- Refer to "5.1.11 Audio Mixer Settings" for more details about the audio settings.

4.1.3.18 How to Use Audio Mixer

GoStream provides an integrated audio mixer, including volume knob and buttons to control the monitoring audio output behavior. It uses the embedded HDMI audio from

your cameras, media servers and other inputs without the need for an external audio mixer. This saves space and makes low cost as you don't need separate audio connections for each video source.

The audio source buttons are **MIC1**, **MIC2**, **IN1**, **IN2**, **IN3**, **IN4** and **AUX**, as shown in Figure 4.1-59. IN1, IN2, IN3, IN4 is corresponding to the embedded audio of HDMI1 to HDMI4 respectively(or SDI1~SDI4), MIC1 and MIC2 is corresponding to analog audio media respectively, and **AUX** is corresponding to the embedded audio of the video source coming from SD card.

PGM represents the mixed audio output using the other audio sources.



Figure 4.1-59 Buttons in Audio Mix Area

■ **Audio Mix-ON and AFV**

The cooperation of ON, AFV and audio sources buttons determines whether audio is always available for mixing or only when the corresponding video source is on air.

i Tips

- Selecting ON option automatically disables AFV, and selecting AFV option automatically disables the direct mix ON setting.

The cooperation relationship of button ON and AFV are list in the following table:

Button	ON	AFV
MIC1	✓	x
MIC2	✓	x
IN1	✓	✓
IN2	✓	✓

Button	ON	AFV
IN3	✓	✓
IN4	✓	✓
AUX	✓	✓
PGM	x	x

☐ **ON: turn the audio output on or off**

ON: press and turn it on, the button is highlighted in white, the current audio input source will be heard permanently, even if the corresponding video source is not currently on air.

OFF: press it again to turn it off, the button is in gray, the current audio input source will not be heard, even if the corresponding video source is currently on air.



Figure 4.1-60 On Button in Audio Mix Area

For example: Press IN1, and then press ON, thus IN1 will be mixed to the audio program output. Press IN2, and then press ON, thus the audio program output will be the mixed audio of IN1 and IN2.

☐ **AFV: turn the audio follows video on or off**

AFV stands for ‘audio follows video’, that is, it will only let the audio input be heard whenever the corresponding video source is switched on air.

To enable or disable AFV for each input, only available for **IN1~IN4** and **AUX**, not available for **MIC1, MIC2**.

ON: press and turn it on, the button is highlighted in white, it will let the audio for the current input video which is on air be heard.

OFF: press it again to turn it off, the button is in gray.

■ Switch input audio source

The audio sources in AUDIO MIX pane are **MIC 1**, **MIC 2**, **IN1**, **IN2**, **IN3**, **IN4**, **AUX**, as shown in Figure 4.1-61.

Press the source button, and then press **ON** button to select this channel to mixing audio output. The selected audio source button will be highlighted in white, or it will turn gray.

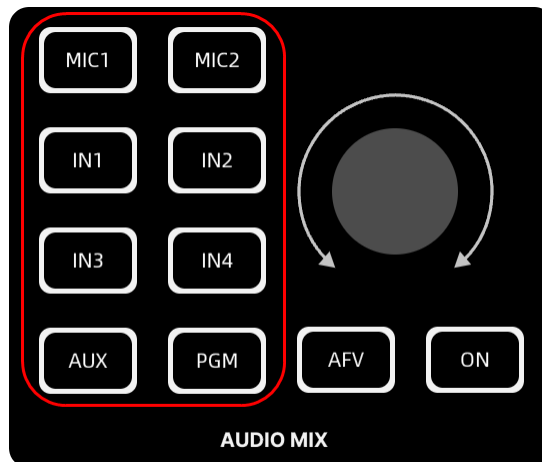

Figure 4.1-61 Audio Sources in Audio Mix Area

■ Audio Level

You will want to control audio levels if the sound is too quiet or too loud. Then, you can adjust the audio levels by knob in AUDIO MIX area, or fader item in menu control.

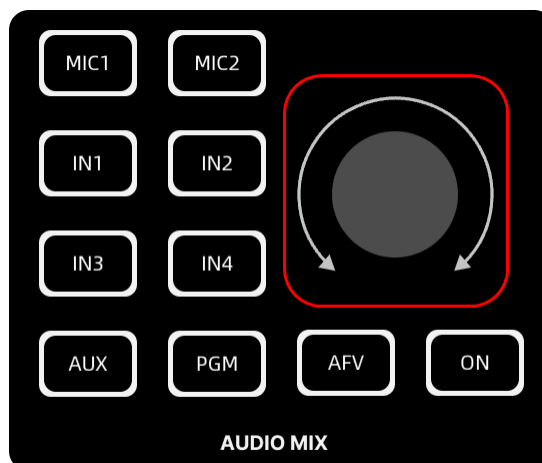

Figure 4.1-62 Audio Knob in Audio Mix Area

Rotate the audio knob in clockwise or counterclockwise to increase or decrease audio level for the respective source or output, and you can monitor the changes in Audio Meter at the right corner of the multiview display.

For example, if the presenter's voice is too loud and risks clipping, you can decrease the audio level by pressing the down button incrementally until the level is safe.

Tips

- Refer to "5.1.11 Audio Mixer Settings" for more details about the fader settings.

- **Output audio level:** the audio knob is used to increase or decrease the audio level for the program output when no audio source is selected currently, that is all the input audio sources are not pressed down.
- **Audio source level:** the audio knob is used to increase or decrease the audio level for the respective source when only one audio source is selected, that is the corresponding audio source is pressed down.

■ Mute

Press the volume knob straight down once to mute the volume output.

■ Set audio parameters for each audio channel

In Audio Mixer menu, you can choose the parameters for each channel by selecting **Audio Mixer** → **channel**, such as **MIC1**, **MIC2** and so on.

■ Audio Delay

Sometimes when using analog audio via MIC inputs, there may be a slight difference in the sync between analog audio and video. Setting the audio delay by setting **Audio Mixer** → **MIC1/ MIC2** → **delay** item will ensure the analog audio input is perfectly synced with the video inputs.

■ Set the audio output source

Use PHONE connector to monitor the switcher output, you can choose a single channel or the mixed channel. Set this parameter by **Audio Mixer** → **monitor** → **source** item, and adjust its audio level by **Audio Mixer** → **monitor** → **level** item.

Tips

- The program output audio will be fading with fade to black operation by selecting the **AFV** item in **FTB** menu.

4.1.3.19 How to Record and Run a Macro

A macro is an easy way to automate a sequence of switcher actions so you can repeat the sequence at the press of a button. GoStream provides up to 8 macro buttons **MEM1~MEM8**, as shown in Figure 4.1-63:

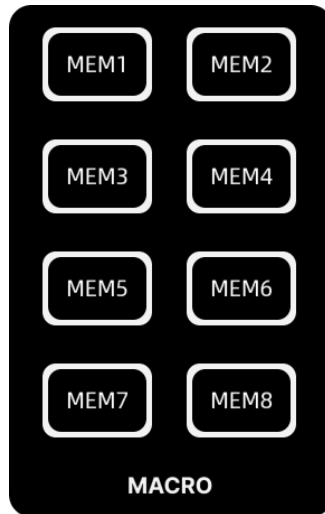

Figure 4.1-63 Macro Buttons

■ Record Macro

Macro is a record which a sequence of transitions between several video sources. The corresponding macro button which is in the process of recording will flash to indicate the progress.

The macro will only record the changes during the recording process. For example, if you want a 3:00 second transition, and your switcher's transition rate is already set to 3:00 seconds, you'll need to change the number, then set it back to 3:00 seconds to record the setting. If not, your desired transition rate will not be recorded.

For example: Record a 2s long wipe transition from IN1 to Still1 on MEM1 button, and pause 2s after pressing IN1. By default, the current PGM input is IN1, and the preview is IN4, and the transition style is WIPE.

The instructions are as below:

Step 1 Select the target macro button

Press the macro button that you want to create your macro, here press MEM1 button, the button is highlighted in flashing white, the recording has started.

Step 2 Set the target program output

Now start performing the switching actions. Press IN2 button or any other button except IN1 on the program bus in order to record the final selection of target

program output. Then press IN1, the real target program output before switching.

Step 3 Set a sleep time

Press **MENU** button on the panel to load the main menu, then set the sleep time through scrolling the menu knob to select **macro**→**macro**→**sleep** menu item, and set it to be 2000ms, as shown in Figure 4.1-64:

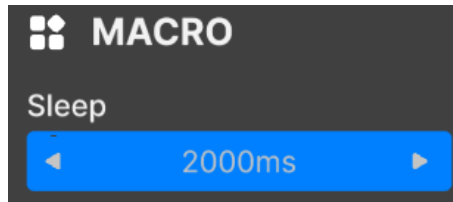

Figure 4.1-64 Sleep Time

Step 4 Set the target preview output

Press STILL1, the real target preview output after switching.

Step 5 Set a transition time

Press **MENU** button on the panel to load the main menu, then set the transition time through scrolling the menu knob to select **transition**→ **wipe** → **rate** menu item, and set it to be 3.

Step 6 Select a transition style

WIPE is already selected, so you must change in order to record. Make sure your macro records the setting by choosing a different transition type, for example the MIX transition, then clicking on WIPE again.

Step 7 Perform transition operation

Press AUTO button to transition automatically. The switcher will perform a transition from IN1 to Still1 in wipe style.

Step 8 Completer recording

When completing all your switcher actions, press MEM1 button again to stop recording this macro. The MEM1 button will be illuminated in highlighted white, and the macro recording is done.

■ Run macro

If your macro was successful, press the corresponding macro button, and the macro will run immediately. You can easily see when a macro is running because the macro button will flash in highlighted white.



- Refer to "5.1.13 Macro Settings" for details about macro parameters.

4.1.3.20 Upload and Set Still Graph

Still button is another input source you can switch to. Press either of the two 'still' buttons to load the still graph to air. Button **Still1** and **Still2** are as shown in Figure 4.1-65:

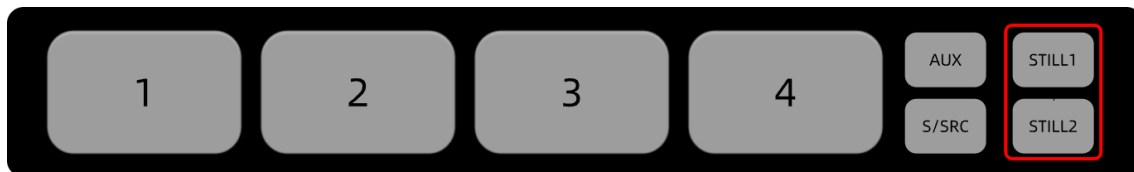

Figure 4.1-65 Still Graph Source Buttons

It will introduce how to upload a still graph, and set it to the still button. The instructions are as below:

■ Upload Still Graph

Step 1 First, select the upload slot

GoStream provides up to 32 graph slots for still graph location.

Select **Still Generator**→**Still Upload**→ **Location** menu item from 0~31 for an upload slot, as shown in Figure 4.1-66.

Step 2 Second, upload still graph

Select **Still Generator**→**Still Upload** → **load picture** menu item, scroll the menu knob to choose the graph which has been stored in the directory "**images\...**" of your SD card. It only supports "*.png" format currently. Press straight down the knob to confirm the selection, it will add this file to the device.

You can upload up to 32 graphs as still graph and you can preview the graph in the menu panel.

The graph for each loaded graph is displayed underneath the slot so you can easily keep track of files you have loaded.

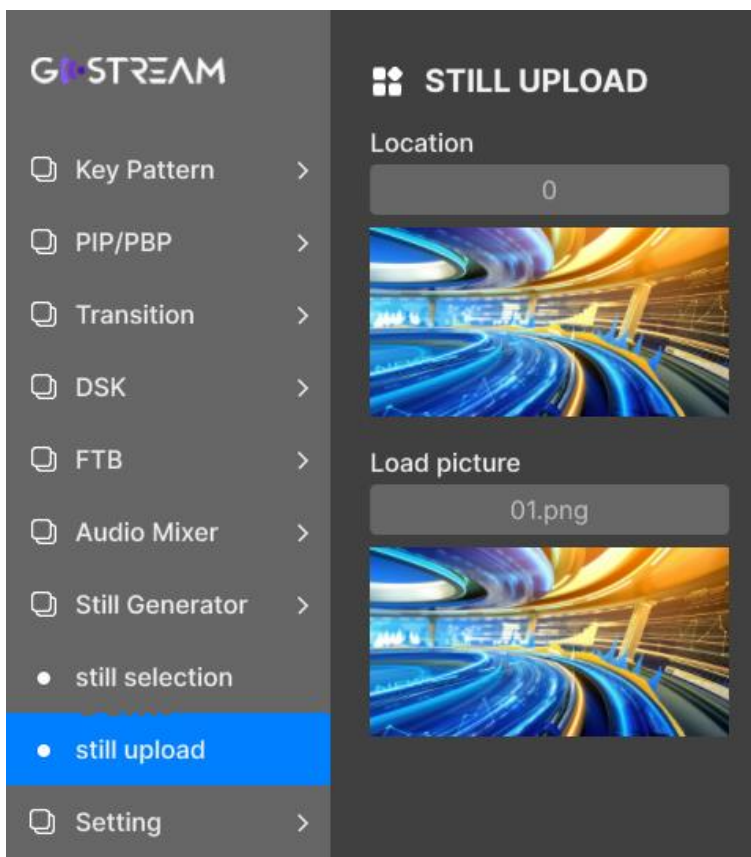

Figure 4.1-66 Load Still Graph

■ **Set Still Graph**

Select a graph ID to Still1 and Still2 respectively, as shown in Figure 4.1-67.

Select **Still Generator**→**Still Selection**→ **still1/still2** to assign your desired graph ID to **still1/still2** from 0 to 31.

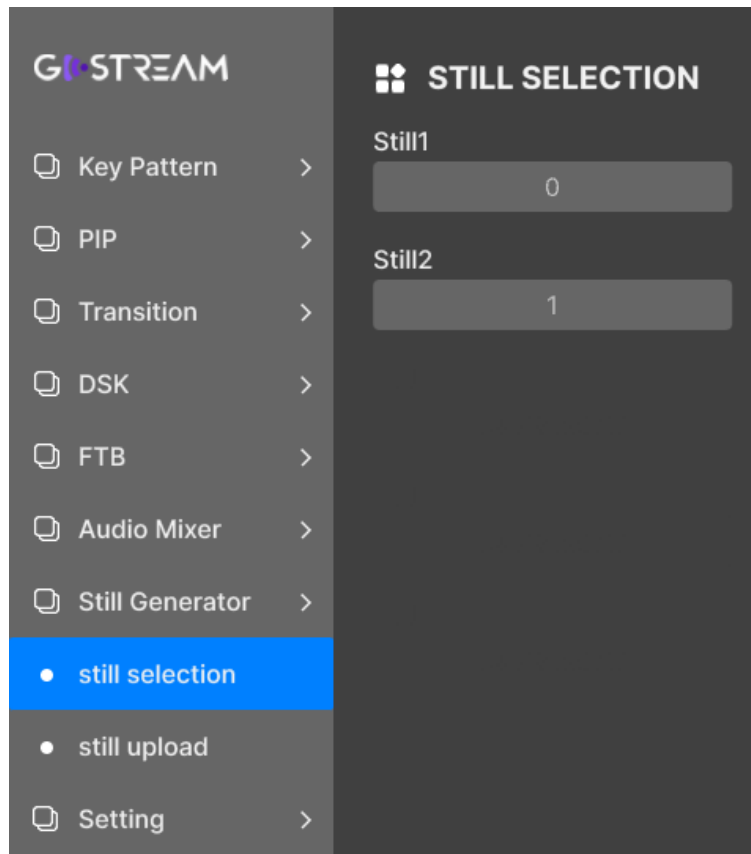

Figure 4.1-67 Select Still Graph ID

Tips

- The graph used as still picture must be saved in the folder named as "**images**" in the root directory of SD card, and we support only "*.png" file format currently.

4.1.3.21 How to Record and Play a Stream

If you are recording your stream via SD card, you can control your start and stop recording by record buttons, and you can also set a customized file name for the record file. Then, you can choose and play the recorded files or videos stored in SD card by play buttons.

The SD card should be formatted as Exfat before recording.

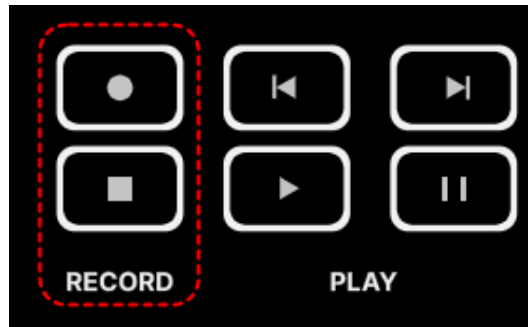

Figure 4.1-68 Buttons for Recording and Playing

■ **How to Record**

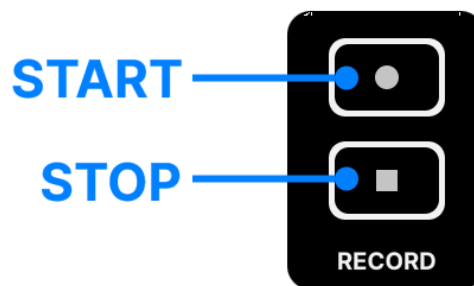



Figure 4.1-69 Record Buttons

Start Recording

Press the start button  in **RECORD** area to start recording, the button will be highlighted in red during the recording process.

Stop Recording

Press the stop button  in **RECORD** area to stop recording, the start button will turn to gray after stopped, and the recorded file will be saved to SD card automatically.

Set Video source-to be recorded by Record operation

The videos recorded into SD card by recording operation usually are called UVC, and the video source could be assigned by **Setting** → **out source** → **Streaming/Recording/UVC** item as IN1, IN2, IN3, IN4, AUX, PGM, PVW or Multiview.

File Name and Directory

The video recorded will be saved automatically to the directory of "Video" folder, as "video\file name.mp4", meanwhile, the file suffix must be "*.mp4"

and the file name is "**FILENAME**+ '_' +timestamp" by default. The timestamp is the starting time of the recording for this file. Set **FILENAME** item by **Setting**→**record file**→**File Name**, or you can leave the content of **FILENAME** item empty.

GoStream use H.264 format for recording to offer a high qualified video.

Tips

- Refer to "5.1.16System Settings" for details about **File Name**, **Recording & Streaming Quality** and **UVC** setting.

Recording View

The current recording status could be spied by the Row2 buttons of the Audio Meter view at the right corner of multiview, as shown in Figure 4.1-70:

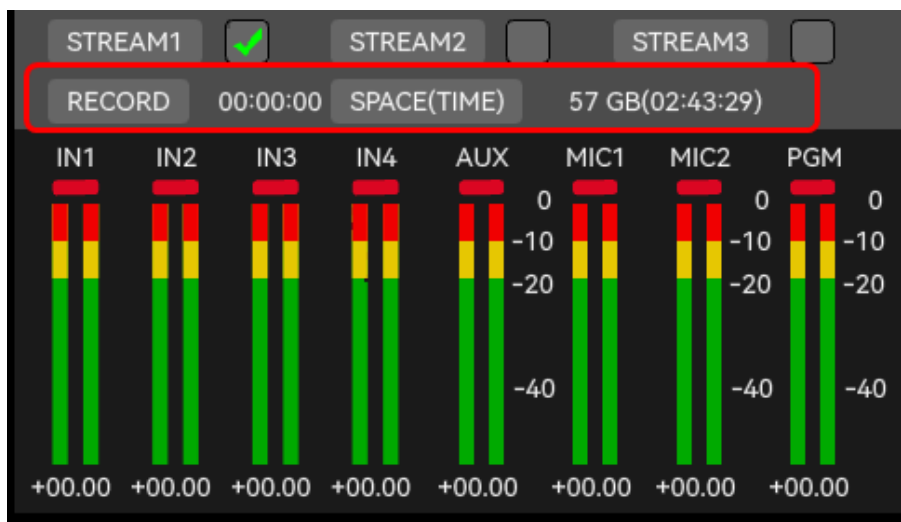

Figure 4.1-70 Recording View

When a disk is recording, the RECORD and SPACE(TIME) button in the recording view will be highlighted in red, and the counter of duration and free space of SD card will start running. Furthermore, the free space will also be converted to a theoretical spare time as suggested.

■ How to Play

Play source

You can choose to play a video saved in videos folder of SD card.

Show the play file list & Select a video to play

You can use the buttons in PLAY area, including **PREV**, **NEXT**, **PLAY** and **PAUSE**, as shown in Figure 4.1-71 to play your desired video.

Long press **PLAY** button to show the play list, which contains all the videos saved in videos folder of SD card.

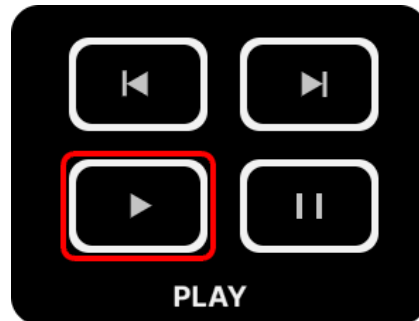

Figure 4.1-71 Play Buttons

Method 1: Switch buttons. Press **PREV** button to play the previous video, and press **NEXT** button to switch to the next one.

Method 2: Long press the play button for 3s in **PLAY** area to navigate a video selection list, the button is as shown in Figure 4.1-71.

Scroll the menu knob clockwise or counterclockwise to choose a file from the list, as shown in Figure 4.1-72, and press the knob straight down to confirm the selection, it will be played in the AUX view of the multiview.

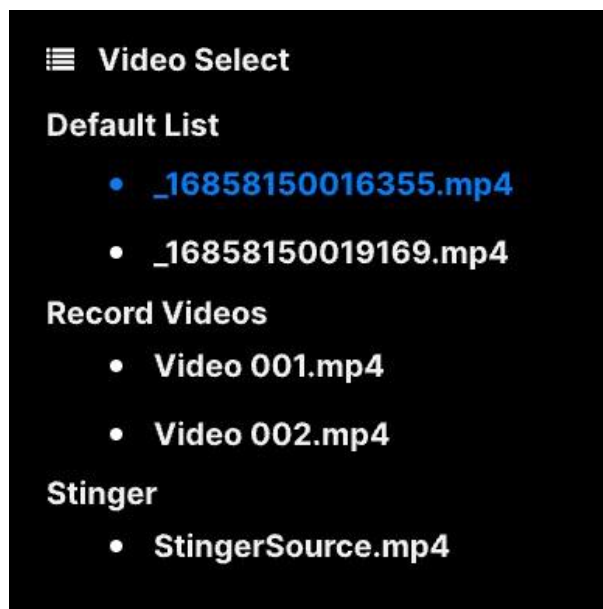

Figure 4.1-72 Video Select List

The videos saved in the SD card are grouped to three lists: **Default List**, **Record Videos** and **Stinger**, as shown in Figure 4.1-72. **Default List** contains the common videos usually provided by customers. **Record Videos**

list contains the recorded videos saved by Record operation as aforementioned. And **Stinger** list contains a Transition video named as StingerSource.

Start & Pause Playing

Short press the PLAY button to play a clip in your SD card, the play button is highlighted in green, then click PAUSE button to pause playing.

Set Playback Mode

Play in one group, Play cross groups:

Set the **PlayBack**→**playback**→**Playback Mode** to **Play in one group** or **Play cross groups** to change the playback mode for the recorded videos in SD card.

The three groups are **Default List**, **Record Videos** and **Stinger**.

Set the playback mode as **Play in one group**, it will play only the videos in current group until the last file in this group, then it will stop playing, and if you press **NEXT** button at that time, it will not switch to the next group.

Set the playback mode as **Play cross groups**, it will play the videos in current group and switch automatically to the next group until the last file in the total video list, then it will stop playing, and if you press **NEXT** button at that time, it will not switch to the next group.

Play in a single video and Repeatly: only play the selected one video in single cycle.

Playback Progress

The progress bar could indicate the playing process of the current video in highlight blue, as shown in Figure 4.1-73, it is displayed at the center of the Audio Meter view at the right corner of multiview.

Set the **PlayBack**→**playback**→**Progress Bar** item to **Enable** or **Disable** to Open or Close the progress bar.

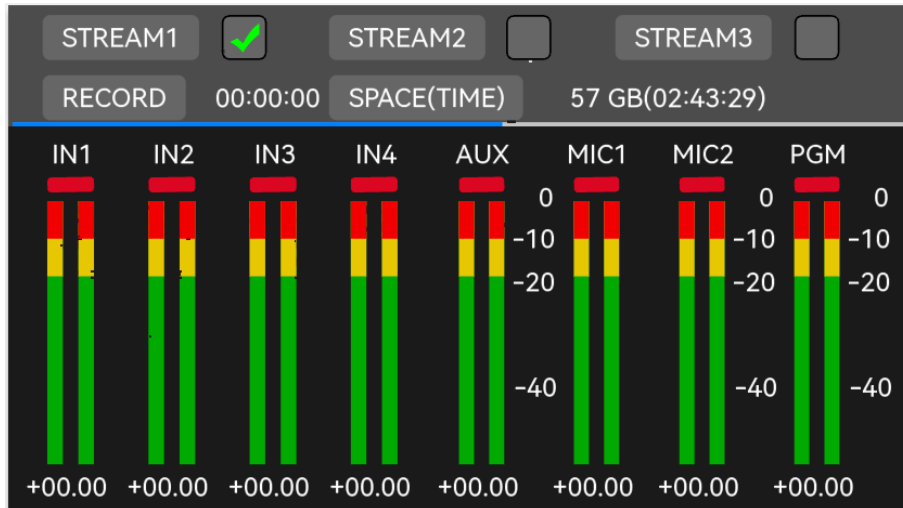

Figure 4.1-73 Playback Progress Bar

Tips

- Refer to "5.1.15 PlayBack Settings" for details about **Playback Mode** setting.

4.1.3.22 Streaming and Broadcasting

GoStream provides direct streaming via **Ethernet** connection or streaming via the webcam output (USB1). The former one sets up a direct stream via your switcher's internet connection which uses a build-in streaming generator without the need for a computer, so you don't need to use any complicated software to get started. The latter one will be recognized as a webcam via the streaming software which is installed in your external broadcast computer, and you must choose the switcher as webcam in the streaming software such as Open Broadcaster for streaming, that will broadcast your switcher's video and audio.

Here's how to stream:

Method 1: Direct streaming via Ethernet

Connect GoStream to Ethernet via Ethernet connector, choose what streaming service you intend to use and enter the streaming key in the STREAM menu. Once you have completed this setup, you can simply press **LIVE** button to go live!

Step 1 Connect to Ethernet

Connect GoStream to Ethernet via Ethernet connector. It may take a moment for DHCP to find the unit and assign an IP address.

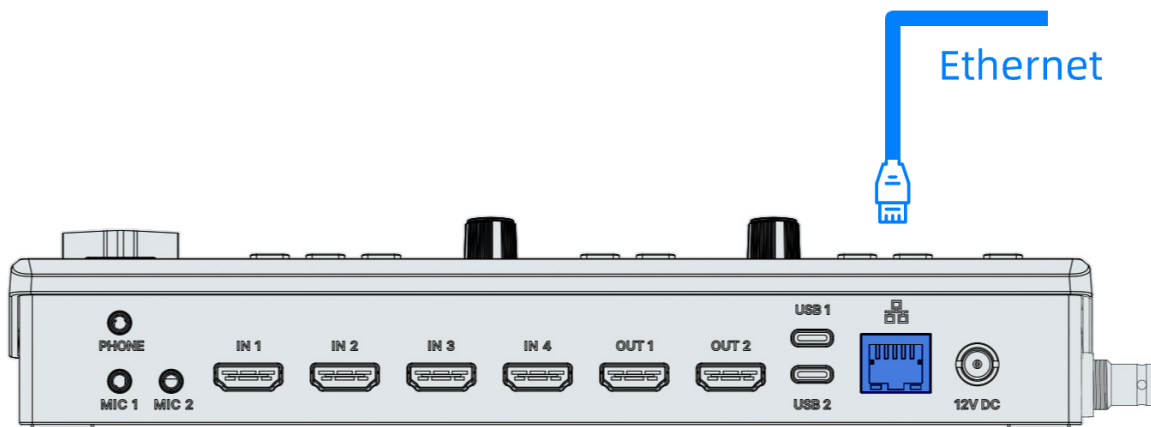

Figure 4.1-74 Ethernet Connection

Step 2 Get a streaming Key from the platform

Logo into your stream broadcasting platform account, an auto generated stream key will appear in the stream settings, get the streaming key, then copy and save it as a txt file. Store this file to your SD card which you will plug into your switcher.

Step 3 Configure the relevant parameters for stream

GoStream provides up to 3 Stream channels that you can broadcast to three streaming applications simultaneously.

Set streaming key, platform and network parameters, etc.

Press **MENU** button to select **Stream** and **Setting** items. Choose what streaming service you intend to use and then enter in the streaming key which should stay consistent to the one on the broadcasting platform. Once you have completed this setup, you can simply press On Air to go live!

- Stream→ Stream***: enter or load the streaming key, choose a platform and enable the selected stream channel.

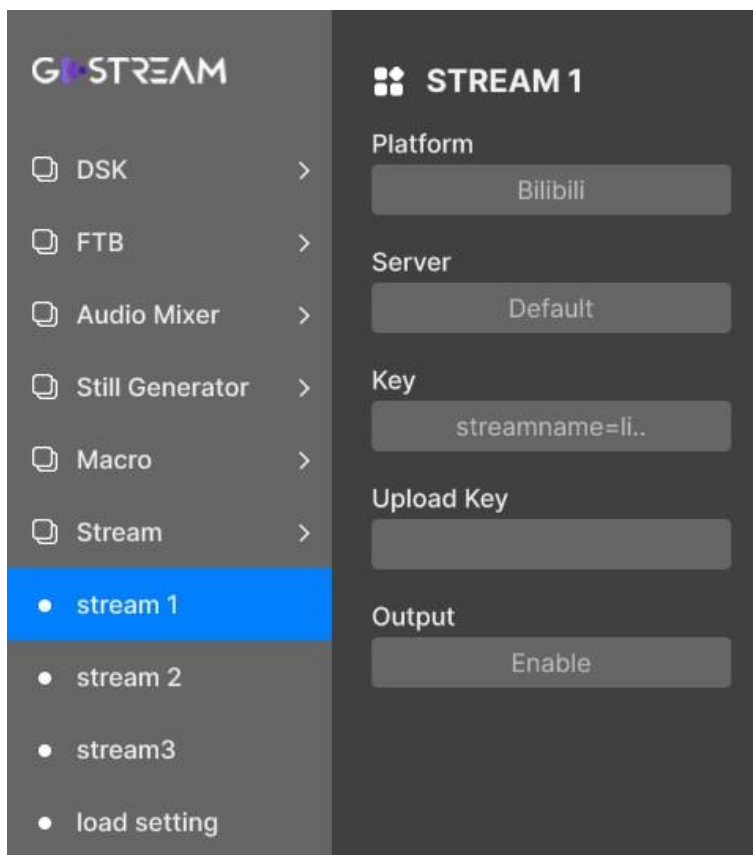

Figure 4.1-75 Stream Menu

- **Setting→ network:** select DHCP and the switcher will get its IP address automatically. Set this setting in **Setting→network** menu.

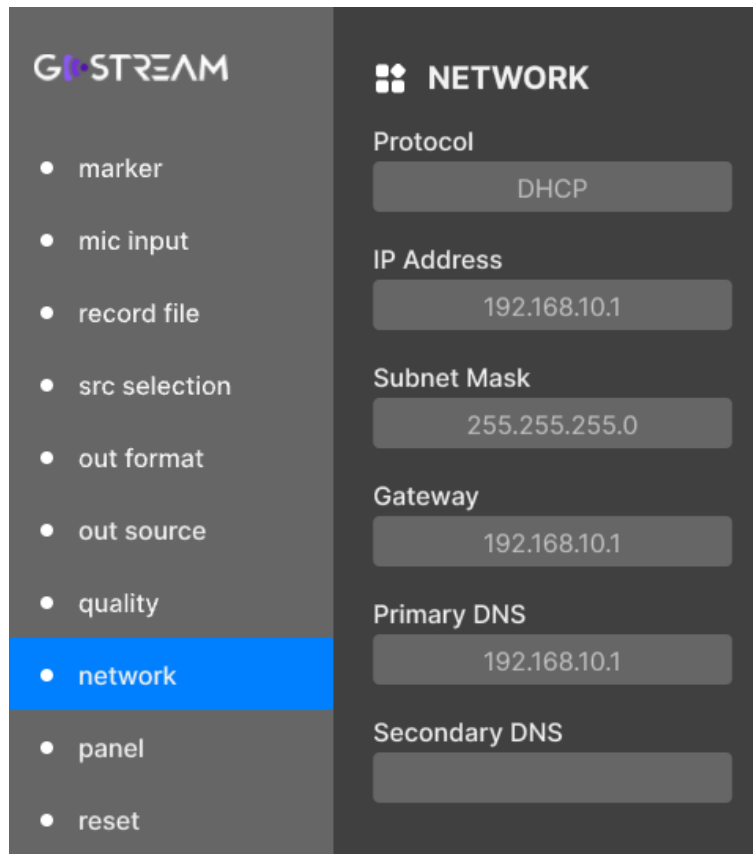

Figure 4.1-76 Network Menu

Tips

- These settings will be stored in your switcher and you can then plug into any internet connection at any time and broadcast directly from the unit.

Step 4 Live and Quit live

Once you have completed the all the relevant settings for your stream, you can simply press **LIVE** button to go live! You are now broadcasting!

When your broadcast has finished, press **LIVE** button again on the switcher, and your stream is stopped.

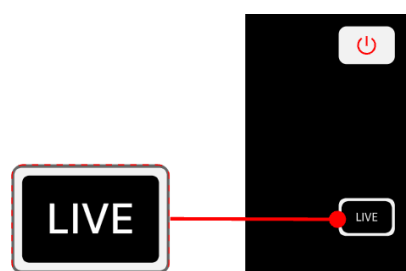

Figure 4.1-77 Buttons for Streaming

Step 5 Monitor Streaming Status

The current living status of Stream1~stream3 could be spied by the Row1 buttons of the Audio Meter view at the right corner of multiview, as shown in Figure 4.1-78:

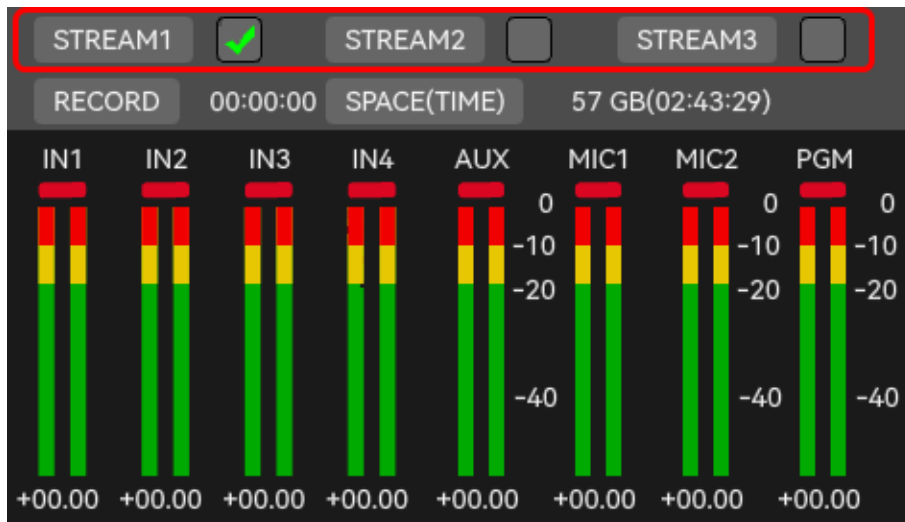

Figure 4.1-78 Streaming View

i Tips

- Set **Stream**→**stream***→**Output** as **Enable** to tick the "**stream***" checkbox, this will activate this stream channel.

Method 2: Streaming via USB as webcam

Connect a cable from your external computer to the USB port on your GoStream, the switcher will be recognized as a webcam.

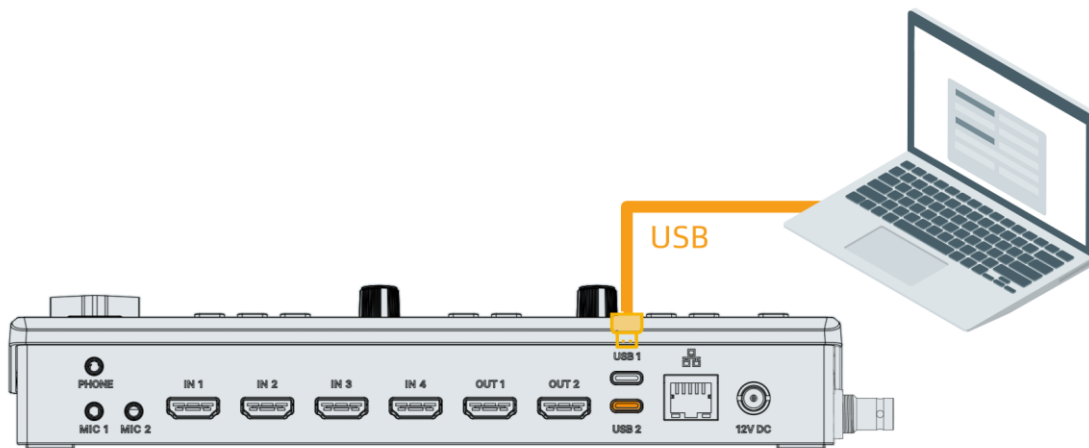

Figure 4.1-79 USB Connection

Once you have connected GoStream, the switcher will be recognized as a webcam, you can check this in your device manager list, as shown in Figure 4.1-80:

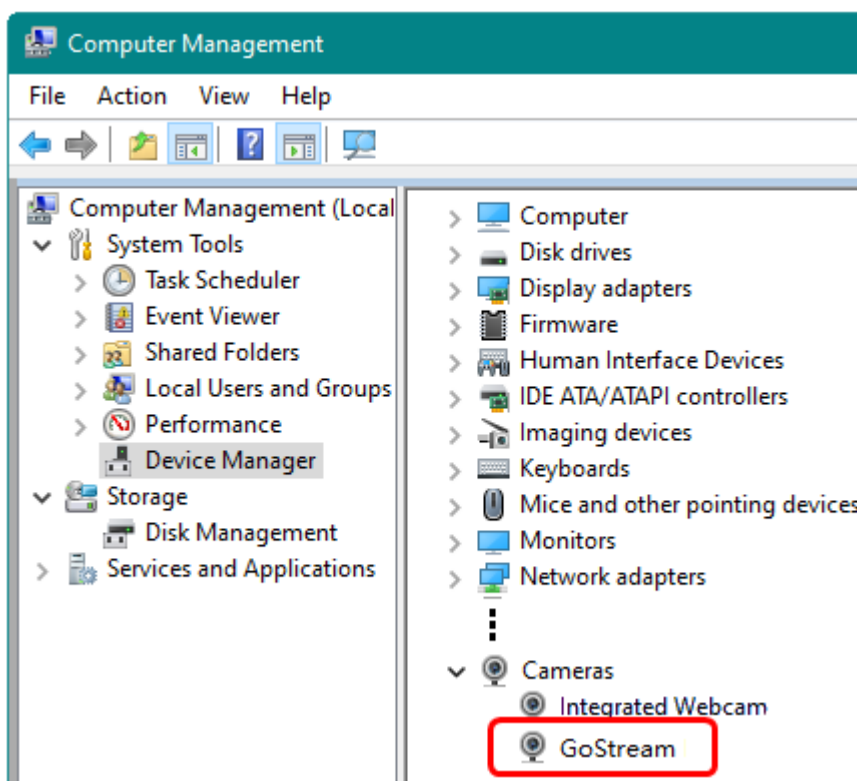

Figure 4.1-80 USB Connection

You can select GoStream as the webcam source in your streaming program, such as Skype, Zoom or OBS Studio.

Take Tencent VooV Meeting for example. After sign up and log in to VooV

Meeting, you can create or join a meeting, then click "Start Video" tab to select GoStream as the webcam source, as shown in Figure 4.1-81:

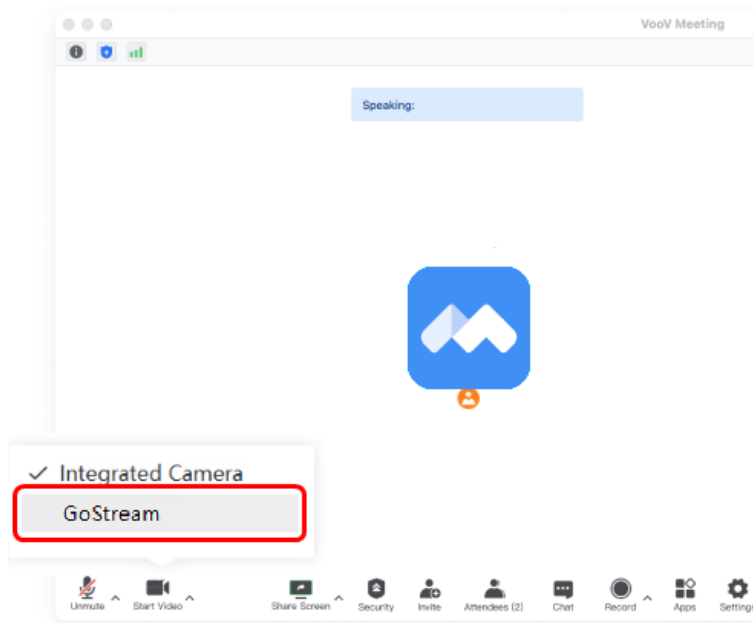

Figure 4.1-81 Recognized as Webcam

i Tips

- Make sure GoStream and the computer on which the streaming program will recognize the switcher as Webcam should be at the same network segment.
- Refer to "5.1.14Stream" for details about **Streaming Key** setting.
- As you're setting up your broadcast, it's worth loading a testing graphic into switcher and switching it to the program output so you can perform a quick test broadcast before actually going live.
- In case of bad video streaming, please take notice to your network connection or internet speed when the stream button's status is yellow.

4.1.3.23 Configuring a Stream Key

Before setting up your stream, you will need to get a stream key first.

This is assigned to your broadcast by your streaming platform, such as YouTube Live, Bilibili, Facebook Live or Twitch, etc. That is, the platform will generate a stream key for your broadcasting.

In the following example you can see how to generate a stream key using YouTube Live software.

Step 1 Log in your YouTube account

YouTube will now supply you with a stream key that will be assigned to your YouTube page.

Step 2 Create stream key

Navigate to the 'video/live' option and click 'get started', then select 'stream' options, enter your broadcast details and click 'create stream'. An auto generated stream key will appear.

Step 3 Copy stream key

Click 'copy' to copy the stream key.

Step 4 Paste stream key

Then, all you need to do is copy the stream key and paste it into the 'key' setting in your switcher's stream options. You have two methods, by manual input or uploading from a key file of SD card. Refer to "5.1.14 Stream Settings" for details.

4.2 CONNECTORS

It will introduce the arrangement and operations of the connectors in the rear panel as follows.

4.2.1 Rear Connectors Arrangement

The rear connectors of GoStream are as shown in Figure 4.2-1:

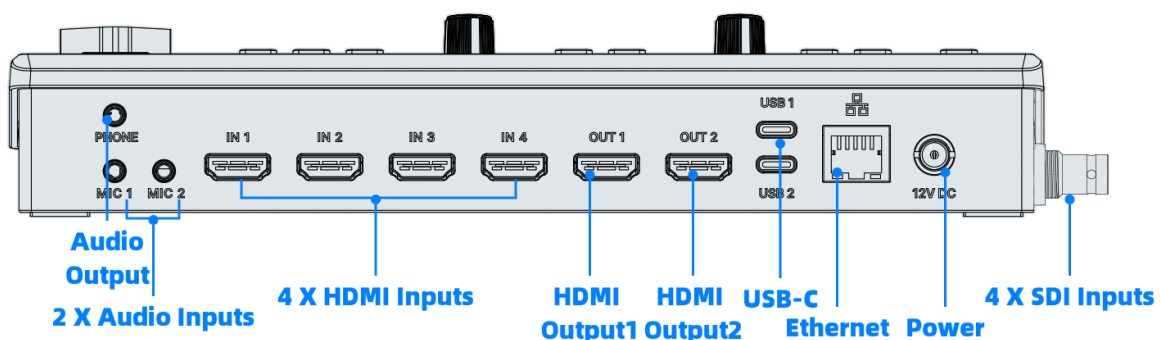

Figure 4.2-1 Connectors on the Rear

1. **PHONE:** audio output of the program output signal

2. **MIC1: audio source input**
3. **MIC2: audio source input**
4. **IN1~IN4: HDMI/SDI input connectors**
5. **OUT1: program output connector**
6. **OUT2: multiview output connector(program output, preview output, Inputs, AUX, internal images and audio levels)**
7. **USB1: video output, connected to control computer as external USB camera for live Apps**
8. **USB2: video input, from USB camera**
9. **Ethernet**
10. **Power Input: 12VDC 12.0A**
11. **SD card: it is used to record the video segments, or store the video sources as AUX input.**

Tips

- GoStream features four HDMI/SDI inputs so you can connect external signal sources, labeled as HDMI1~HDMI4, SDI1~SDI4 separately.
- The signal source displayed as AUX could be videos from SD card or external webcam, choose this by setting **Setting → src selection → AUX** to be **Sd card** or **Usb camera**.

4.2.2 Rear Connectors Operations

The details of these connectors at the rear panel are described as follows:

1. **PHONE**

It provides one audio output interface for monitoring the program output, labeled as **PHONE**. The output channel is specified by the parameter setting by **Audio Mixer→monitor→source** item.

Tips

- Set the phone parameters by **Audio Mixer**→**monitor** item, refer to "5.1.11 Audio Mixer Settings" for details.

2. MIC(3.5mm Jack)

It supports two analog audio source channels, labeled as MIC1, MIC2. MIC1 and MIC2 inputs let you connect external analog audio, Such as music players.

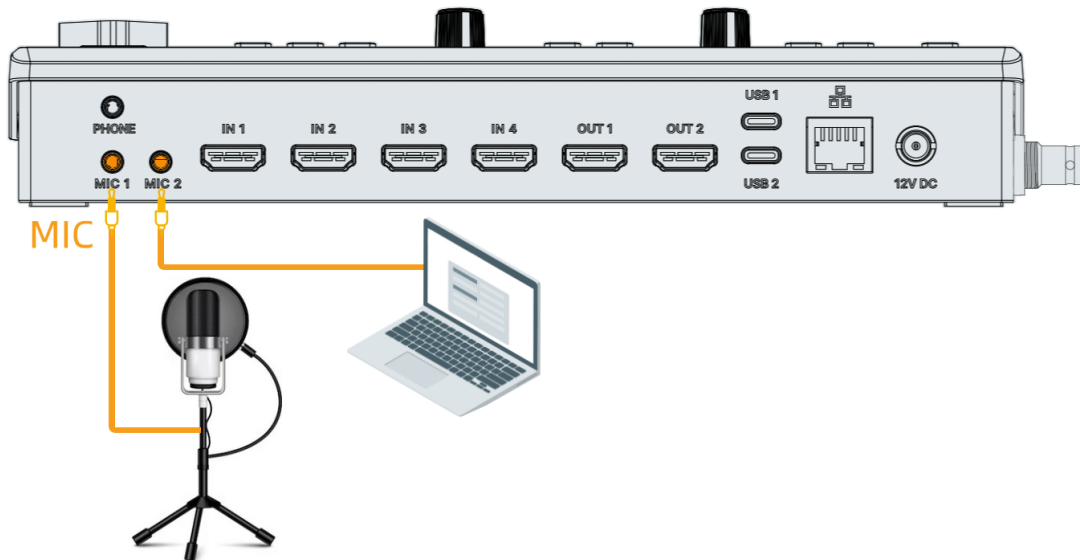

Figure 4.2-2 HDMI Inputs

Tips

- Set channel parameters by **Audio Mixer**→**monitor**→ **MIC1/MIC2**, refer to "5.1.11 Audio Mixer Settings" for details.
- Set input types for MIC1/MIC2 by **Setting**→ **Mic input** → **Mic1 input/Mic2 input** as **Mic**, **Mic+power** or **Line**, refer to "5.1.16 System Settings" for details.

3. IN1~IN4

It supports four HDMI inputs, labeled as IN1, IN2, IN3, IN4.

Plug your HDMI/SDI cameras and other HDMI/SDI sources into the switcher's inputs.

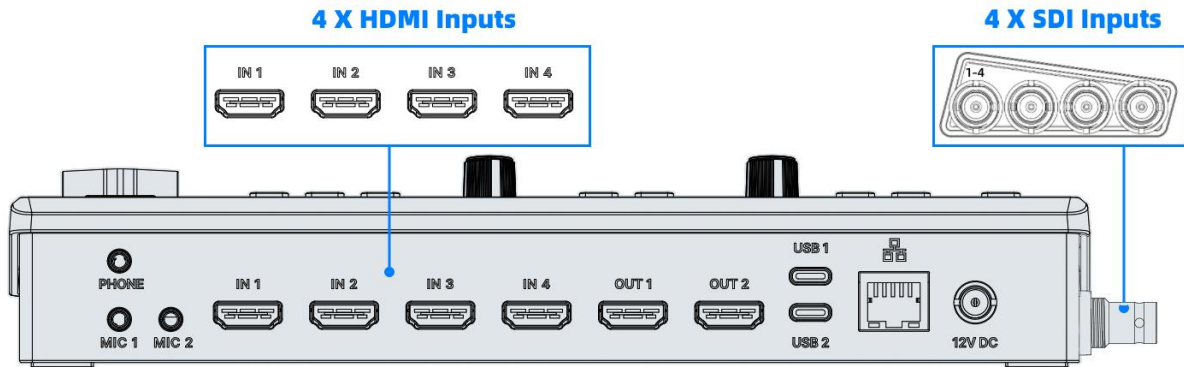

Figure 4.2-3 HDMI Inputs

4. OUT1: program output

It supports one program output, labeled as OUT1.

Plug an HDMI television or monitor into your switcher’s HDMI output1 so you can monitor your program output and check all your sources are working properly.

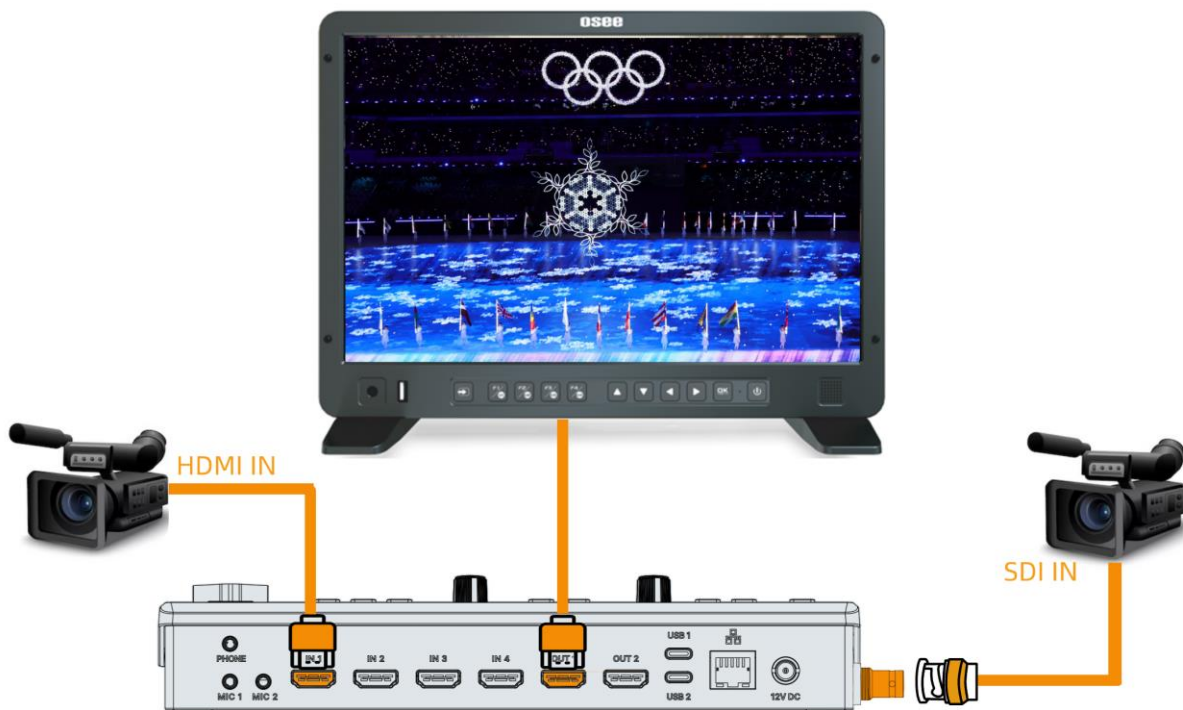

Figure 4.2-4 Monitoring HDMI Output1

i Tips

- Set output format by **Setting** → **output format** → **Format**, refer to "5.1.16 System

Settings" for details.

- Set out source for OUT1 by **Setting**→ **out source**→ **In1** by default, otherwise, set it as In 2, In 3, In 4, Aux, PGM, PVW or Multiview, refer to "5.1.16 System Settings" for details.

5. OUT2: Multiview output

It supports one multiview output, labeled as OUT2.

Plug an HDMI television or monitor into your switcher's HDMI output2 so you can monitor your multiview, including program output, preview output, four HDMI/SDI inputs, AUX input, two still images and audio levels plus streaming status, recording time and free space in SD card. And you can load the main menu on multiview to set the specific settings for the device.



Figure 4.2-5 Multiview Display

Tips

- The output source for OUT2 is set to multiview by default, and unchangeable in device settings, but you can change it in GoStream control software on PC.

6. USB1:

It supports one USB output, labeled as USB1. It is connected to control computer as external USB camera for live Apps. It acts as a USB UVC/webcam output, set its output source by **Setting**→**output source**→ **Streaming/Recording/UVC** settings.

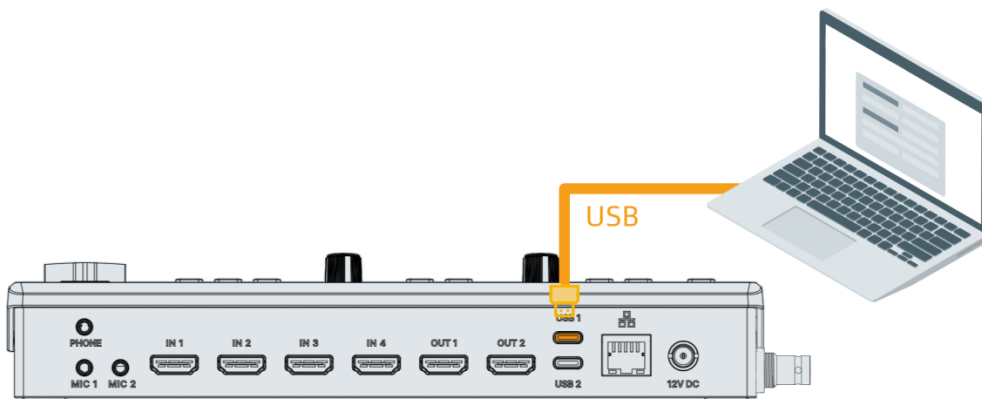

Figure 4.2-6 Output as Webcam

7. USB2

It supports one USB input, labeled as USB2. It acts as an AUX input, often connect a webcam as input, set this channel as AUX source by **Setting**→**src selection**→**AUX** as **Usb camera**.

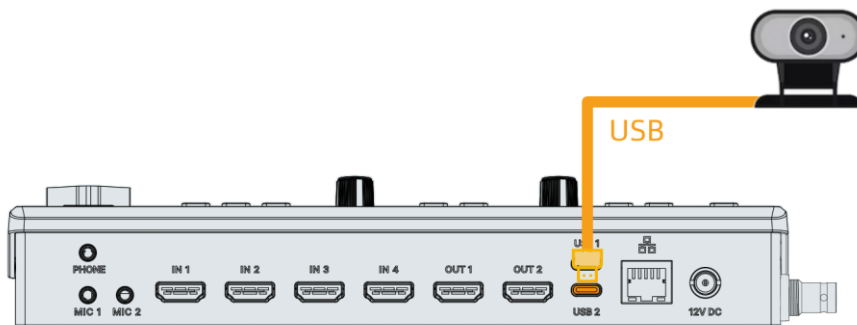

Figure 4.2-7 Connect a Webcam as AUX Source

8. Ethernet(RJ-45)

It supports one 10/100M Ethernet connector. Connect GoStream to a network via Ethernet to broadcast on live.

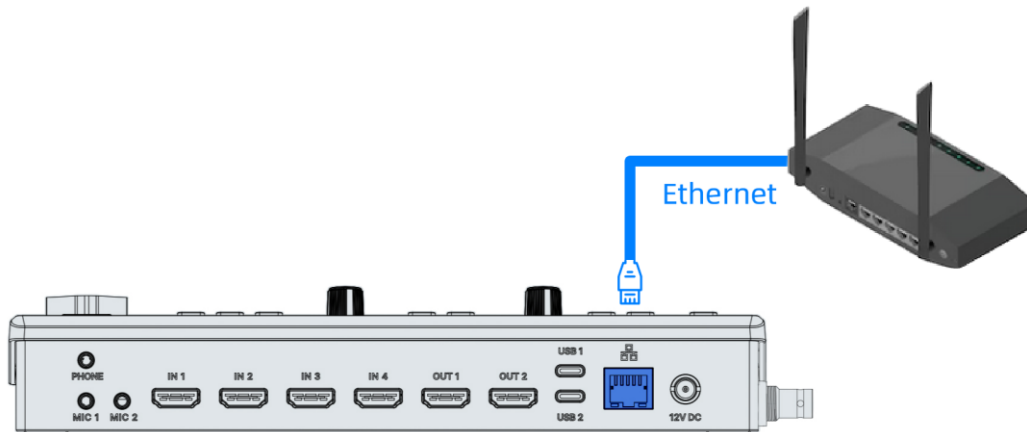

Figure 4.2-8 Plug Switcher to Ethernet

Tips

- When connecting to a network, set the switcher to DHCP. The network server will assign an IP address to your switcher automatically.

9. Power

It provides one DC power connector, 12V DC.

Plug in power supply using the supplied power adapter. Tighten the connector to the unit with the locking ring to secure the connection to the switcher. This locks the power cable to the device preventing it from being accidentally removed.

Warning

- Only use the adapter and the power cord specified by the manufacture for your safety!

10. SD card: AUX or UVC

You can take SD card as a kind of video source that uses the videos stored in this unit, or as a recording and storage medium.

- As video source

It provides video sources which are stored in SD card. Set the menu item **Setting** → **src selection** → **AUX** as **SD card**. The videos stored in the folder named as **videos** will be displayed in the AUX view of multiview.

- As recording and storage medium

Besides, SD card is also used to record the UVC contents. Use the start and stop button in RECORD area to start or stop recording. The video source of the recorded segments could be assigned by **Setting→ out source→**

Streaming/Recording/UVC item as IN1, IN2, IN3, IN4, AUX, PGM, PVW or Multiview.

SD card is used to store still images, profiles (Macro, system settings, etc.), stream key, update files, playback video and recorded video, the directory tree in this card is as shown in Figure 4.2-9:

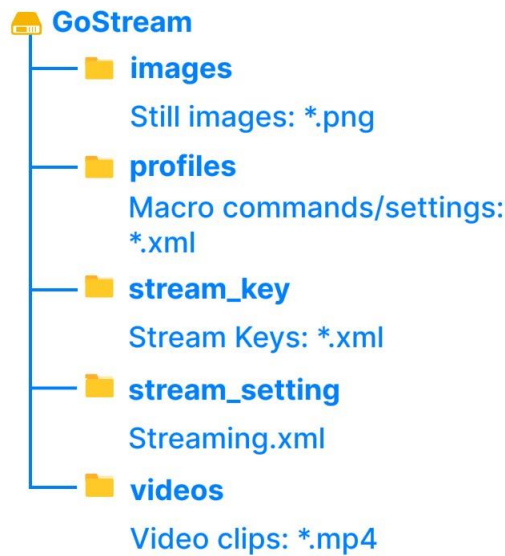

Figure 4.2-9 Directory Tree in SD Card

The videos in the videos folder of SD card will be labeled by three tags, that is the videos are divided into three groups: **Default List**, **Recorded Videos** and **Stinger**. The directory tree in this video select list is as shown in Figure 4.2-10.

The common videos which are copied by customers to the **videos** folder in SD card are usually played as Aux source. The recorded video segments which are saved to **videos** folder by recording operation are listed below the **Recorded Videos**. The transition video listed below the **Stinger Videos** must be named as StingerSource. You can playback these videos in one group or cross groups, set this by using the menu item **PlayBack→playback→ PlayBack Mode**.

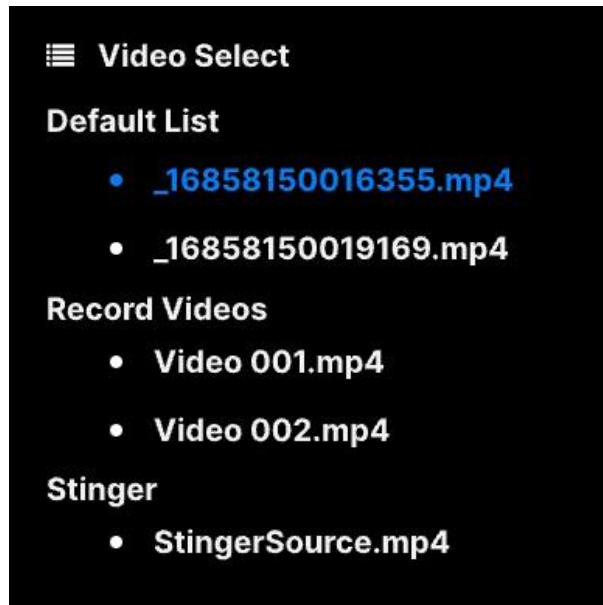

Figure 4.2-10 Video Select List

Tips

- When inserting the SD card for the first time, it will create the above folders automatically, as shown in Figure 4.2-9. Then you must store your customized files into its folder of the corresponding type, don't put the file in the root directory of SD card!
- Refer to "5.1.16 System Settings" for details about **AUX** and **UVC** setting.
- Refer to "4.1.3.21How to Record and Play a Stream" for details about **UVC** store.
- If you select the DIP transition (Press **DIP** button down), and you have saved a stinger file named as stingersource.mp4 to the videos folder in SD card, this unit will load this video in the dip transition.

4.2.3 GoStream Control Software on PC

GoStream provides a control software which allows configuring and controlling the GoStream unit on the host computer. It features a group of vivid virtual panels and menu settings on PC as the same as the real GoStream unit, that you can operate GoStream more conveniently.

This section describes how to connect the GoStream live switcher to the host computer. There are two methods to connect the host computer and GoStream unit.

■ Method 1: Through the USB interface

Connect the PC's USB interface to the USB1 port of GoStream by a USB cable, as shown in the diagram below:

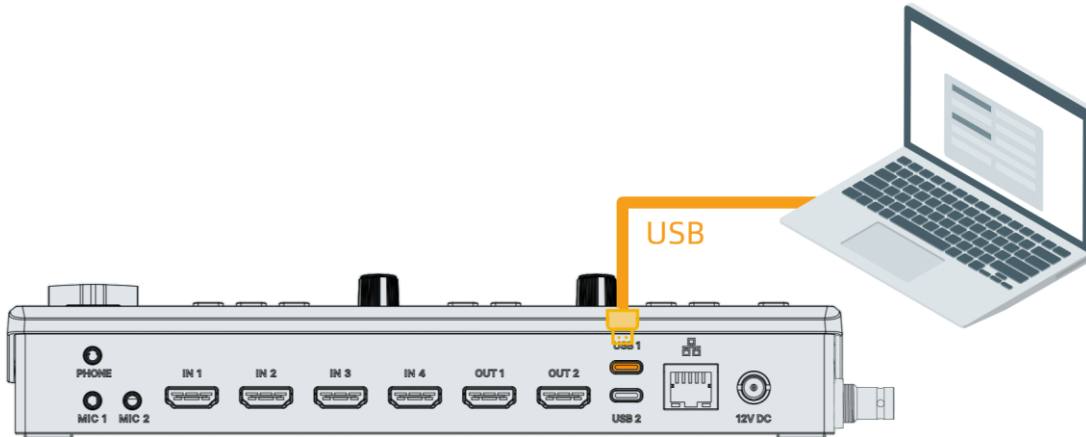

Figure 4.2-11 Connect PC through USB

■ Method 2: Through the Ethernet

Connect PC and GoStream by network, they must be connected to the network in the same segment, as shown in the diagram below:

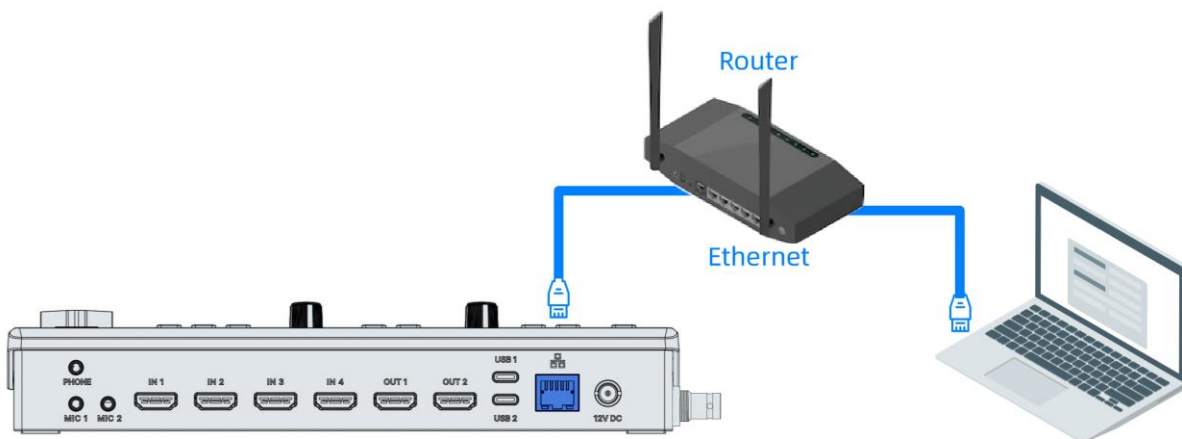

Figure 4.2-12 Connect PC through Ethernet

4.3 Support Format

Table 4.3-1 Output Signal Format

Format	IN*	OUT*
720P24/23.98	✓	
720P25	✓	
720P30/29.97	✓	
720P50	✓	
720P60/59.94	✓	
1080I50	✓	
1080I60/59.94	✓	
1080P23.98	✓	
1080P29.97	✓	
1080P59.94	✓	
1080P24	✓	✓
1080P25	✓	✓
1080P30	✓	✓
1080P50	✓	✓
1080P60	✓	✓

Chapter 5 MENU OPERATIONS

The **Main Menu** allows you to configure the switcher, press **MENU** button to show the main menu, as shown in Figure 5-1:

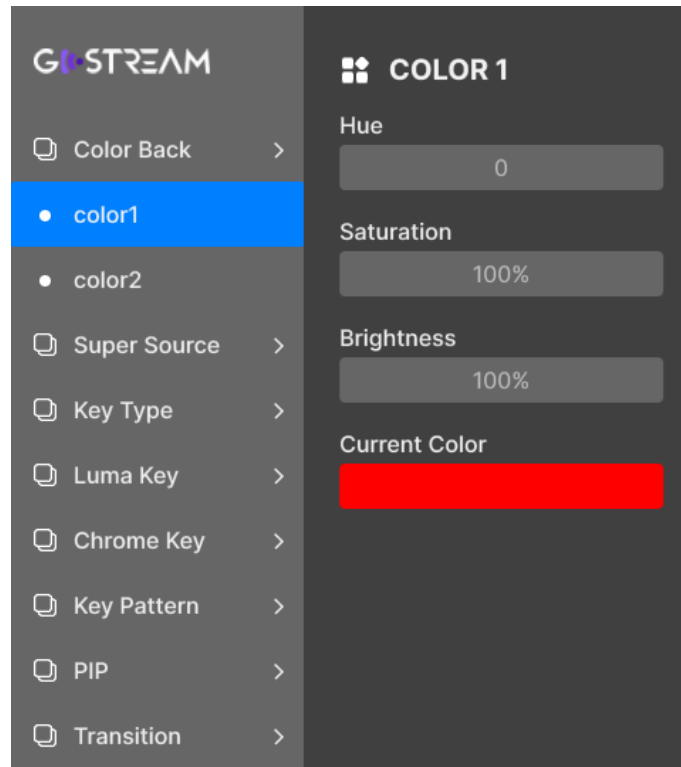

Figure 4.3-1 Main Menu

This section includes the following menus:

- **Color Back:** set the color generators to two customized colors.
- **Super Source:** set a splicing display which will allow you to arrange multiple sources on the monitor at one time as an input for the switcher.
- **Key Type:** set the type of the upstream keyer.
- **Luma Key:** set parameters for luma key.
- **Chrome Key:** set parameters for chrome key.
- **Key Pattern:** set parameters for pattern key.
- **PIP:** set parameters for PIP key.

- **Transition:** set parameters for transition.
- **DSK:** set parameters for downstream keyer.
- **FTB:** set parameters for FTB.
- **Audio Mixer:** set parameters for audio mixer.
- **Still Generator:** set parameters for still generator.
- **Macro:** set parameters for macro.
- **Stream:** set parameters for stream.
- **Playback:** set parameters for playback.
- **Setting:** set system parameters.

5.1 Main Menu

Press **MENU** button on the panel, and it will pop up the main menu pane at the right corner of multiview interface, as shown in Figure 5.1-1:

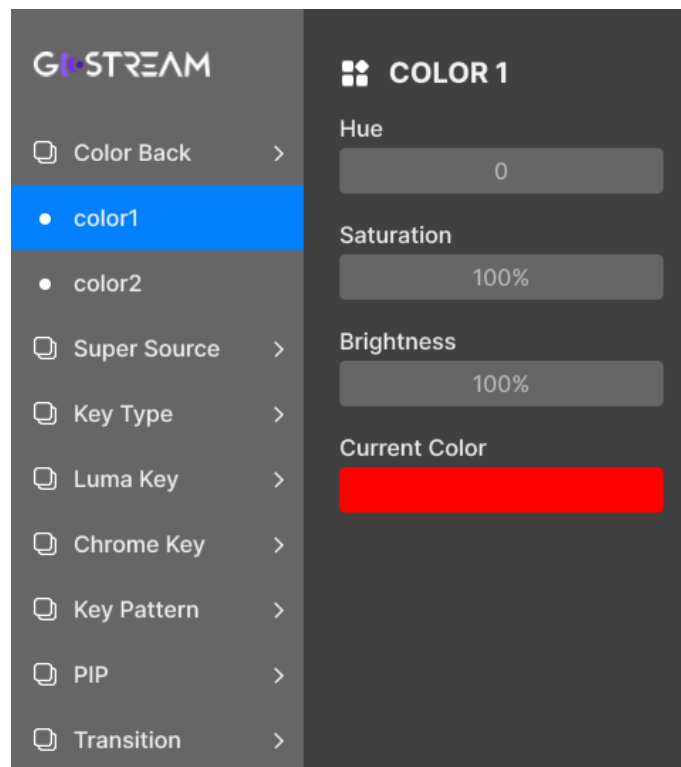

Figure 5.1-1 Main Menu

The menu pane is divided into two parts: the left list and the right list. Follow the instructions below:

1. Menu List

It will display the menu list at the left part of the main menu pane. Scroll the menu knob clockwise or counterclockwise to navigate the items, then press the knob straight down to show the submenu list below the menu item, the selected item will be highlighted in bright blue.

2. Parameter List

The details of the selected menu item are located just at the right part of menu pane. You can check the parameters of the current selected menu item.

Press the knob straight down to enter the parameter list. Scroll the menu knob clockwise or counterclockwise continuously to switch among its options. Press the knob straight down to set values, scroll left to decrease the item value or select the previous item, while scroll right to increase its value or select the next item.

Tips

- There is a highlighted control icon when you select the menu or its value in the sub-menu list.
-

The following will introduce the contents and functionality of these menu items.

5.1.1 Color Back Settings

The switcher has two color generators which can be configured in Color Back menu by setting hue, saturation, and brightness, as shown in Figure 5.1-2:

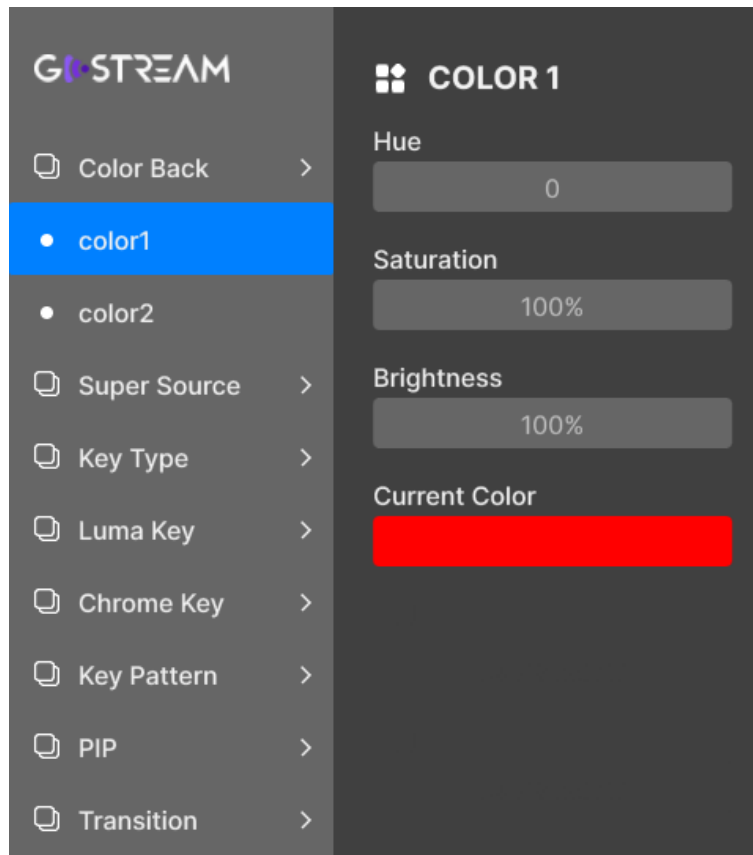

Figure 5.1-2 Color Back Menu

The relationship of Items, Default Value, Domain Range and Description of the sub-item is shown in Table 5.1-1:

Table 5.1-1 Description of Color Back Menu Items

Items	Default	Domain Range	Description
color1			
Hue	0	0~359, 1 step	Set hue for color1
Saturation	0	0%~100%, 1% step	Set saturation for color1
Brightness	100	0%~100%, 1% step	Set brightness for color1
Current Color	---	---	Display color1 sample. Use this indicator to verify the color that you selected
color2			
Hue	0	0~359, 1 step	Set hue for color2
Saturation	100	0%~100%, 1% step	Set saturation for color21
Brightness	100	0%~100%, 1% step	Set brightness for color2

Items	Default	Domain Range	Description
Current Color	---	---	Display color2 sample. Use this indicator to verify the color that you selected

■ **Color Wheel**

As shown in Figure 5.1-3, hue is the degree on the color wheel, and the range is from 0 to 360. You can set a color in terms of hue, saturation and brightness.

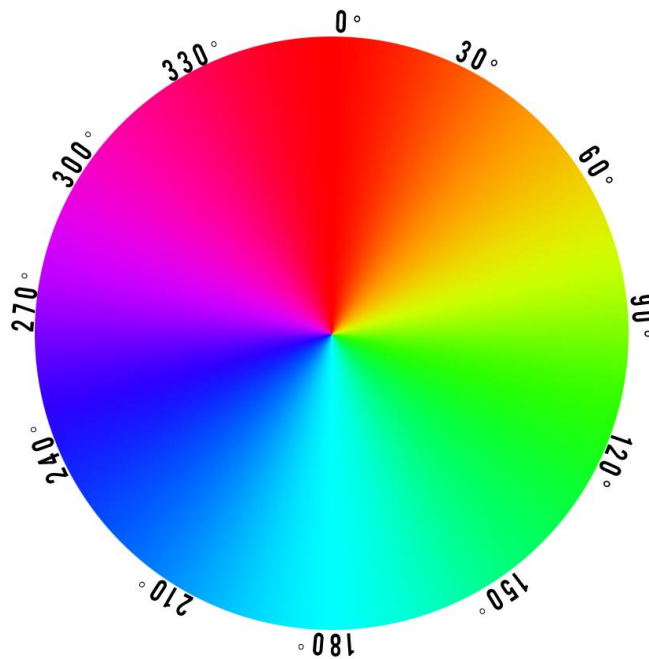

Figure 5.1-3 Color Wheel Reference

i Tips

- You can set color1 and color2 in Luma Key, Chroma Key, Key Pattern, PIP, DSK menu as Fill source or Key source in the following section.

5.1.2 Super Source Settings

Use Super Source menu to set a splicing display which will allow you to arrange multiple sources on the monitor at one time as an input for the switcher, the menu items are as shown in Figure 5.1-4:

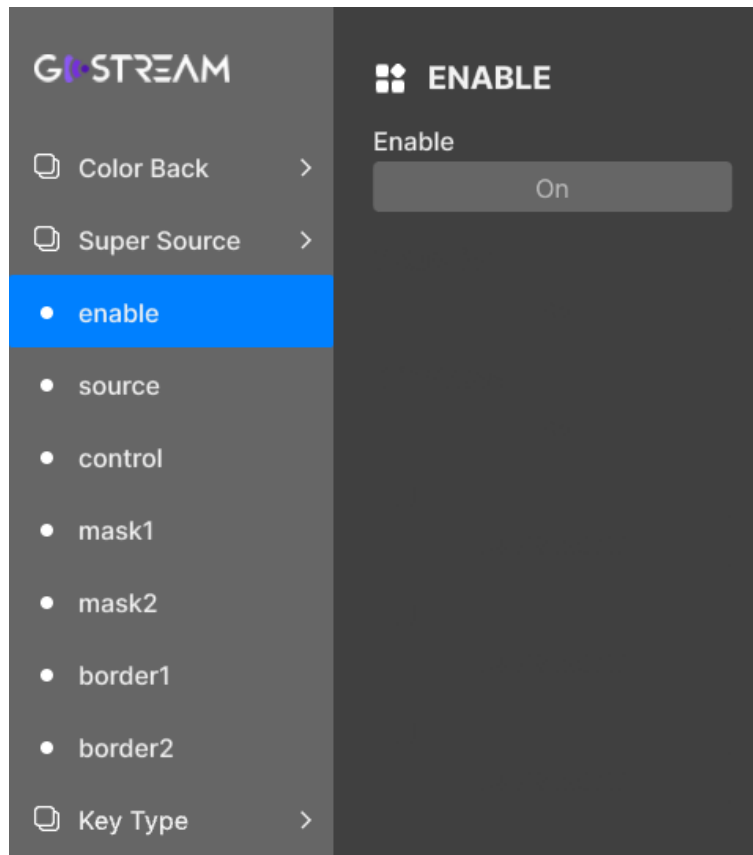

Figure 5.1-4 Super Source Menu

The relationship of Items, Default Value, Domain Range and Description of the sub-item is shown in Table 5.1-14:Table 5.1-2

Table 5.1-2 Description of Super Source Menu Items

Items	Default	Domain Range	Description
enable			
Enable	On	On/Off	Enable/Disable Super Source. Enable super source, the button S/SRC will be assigned as a splicing input source, otherwise button S/SRC will only provide an internal black signal.
source			
Source1	In 1	In 1/In 2/In 3/ In 4/Aux/ Still 1/Still 1 Key/ Still 2/Still 2 Key/ Color 1/Color 2/ Color Bar/Black	Set Source1 for super source
Source2	In 2	In 1/In 2/In 3/	Set Source2 for super source

Items	Default	Domain Range	Description
		In 4/Aux/ Still 1/Still 1 Key/ Still 2/Still 2 Key/ Color 1/Color 2/ Color Bar/Black	
Background	Still 1	In 1/In 2/In 3/ In 4/Aux/ Still 1/Still 1 Key/ Still 2/Still 2 Key/ Color 1/Color 2/ Color Bar/Black	Set background source for super source, it will display below Source1 and Source2
control			
Style	Zoom in	Zoom in/Crop/ Zoom in-Crop/ Crop-Zoom in	Set the splicing type for super source
Y Position	50%	0%~100%	Set the vertical starting position for splicing display. Decrease its value to move upward, and increase to move downward.
mask1			
Enable	Off	On/Off	Enable/Disable crop for source1
H Start	0%	0%~100%	Set the crop size from left side for source1
V Start	0%	0%~100%	Set the crop size from top side for source1
H End	100%	0%~100%	Set the crop size from right side for source1
V End	100%	0%~100%	Set the crop size from bottom side for source1
mask2			
Enable	Off	On/Off	Enable/Disable crop for source2
H Start	0%	0%~100%	Set the crop size from left side for source2
V Start	0%	0%~100%	Set the crop size from top side for source2
H End	100%	0%~100%	Set the crop size from right side for source2
V End	100%	0%~100%	Set the crop size from bottom side for source2

Items	Default	Domain Range	Description
Enable	Off	On/Off	Enable/Disable crop for source2
border1			
Width	0%	0%~10%	Set the border width for source1
Hue	45	0~359	Set the border's hue for source1
Saturation	100%	0%~100%	Set the border's saturation for source1
Brightness	100%	0%~100%	Set the border's brightness for source1
Current Color	---	---	Display the color sample for source1
border2			
Width	0%	0%~10%	Set the border width for source2
Hue	45	0~359	Set the border's hue for source2
Saturation	100%	0%~100%	Set the border's saturation for source2
Brightness	100%	0%~100%	Set the border's brightness for source2
Current Color	---	---	Display the color sample for source2

Tips

- You can set the display style for Super Source view by selecting **Control**→**Style** item, refer to "4.1.3.2Display Splicing" for more details about the two styles.

5.1.3 Key Type Settings

You can assign an upstream keyer type for button **KEY** in this menu, including luma key, chroma key, pattern key or PIP key, the menu items are as shown in Figure 5.1-5:

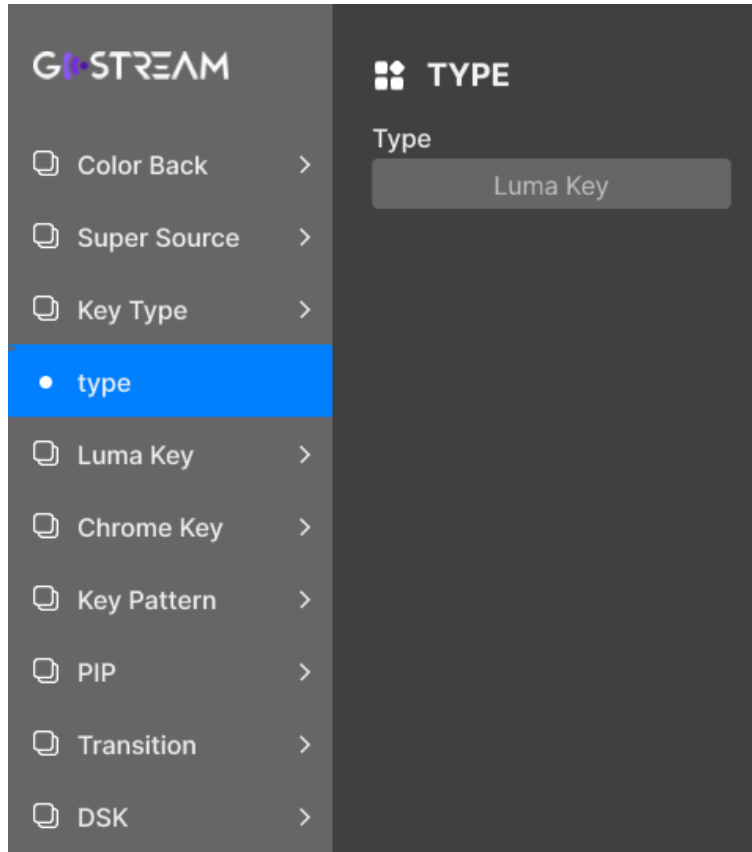

Figure 5.1-5 Key Type Menu

The relationship of Items, Default Value, Domain Range and Description of the sub-item is shown in Table 5.1-3:

Table 5.1-3 Description of Key Type Menu Items

Items	Default	Domain Range	Description
Type	Luma key	<ul style="list-style-type: none"> • Luma key • Chroma key • Pattern • PIP 	Set the pattern type for button KEY

i Tips

- Set the upstream keyer type for button KEY in this menu.
- Refer to "5.1.4 LUMA Key " for details about Luma Key parameter settings.
- Refer to "5.1.5 Chrome Key " for details about Chroma Key parameter settings.
- Refer to "5.1.6 Key Pattern " for details about Pattern Key parameter settings.

- Refer to "5.1.7 PIP " for details about PIP Key parameter settings.

5.1.4 Luma KEY Settings

Set luma key as an upstream keyer to button **KEY**, and set its parameters in this menu, the menu items are as shown in Figure 5.1-6:

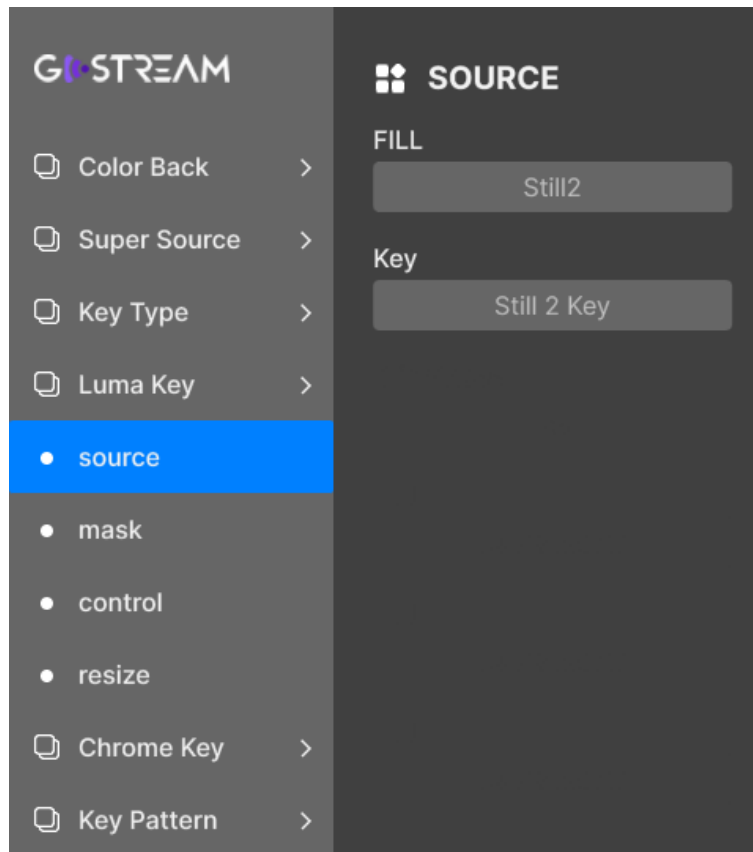

Figure 5.1-6 Luma Key Menu

The relationship of Items, Default Value, Domain Range and Description of the sub-item is shown in Table 5.1-4:

Table 5.1-4 Description of Luma Key Menu Items

Items	Default	Domain Range	Description
source			
Fill	Still 2	In 1/In 2/In 3/In 4/Aux/ Still 1/Still 1 Key/ Still 2/Still 2 Key/ Color 1/Color 2/	Set the fill source

Items	Default	Domain Range	Description
		Color Bar/Black	
Key	Still 2 Key	In 1/In 2/In 3/In 4/Aux/ Still 1/Still 1 Key/ Still 2/Still 2 Key/ Color Bar/Black	Set the key source
mask			
Enable	Off	On/Off	Enable/Disable mask
H Start	0%	0%~100%	Set the starting X-coordinate for mask
V Start	0%	0%~100%	Set the starting Y-coordinate for mask
H End	100%	0%~100%	Set the ending X-coordinate for mask
V End	100%	0%~100%	Set the ending Y-coordinate for mask
control			
Shaped Key	Off	On/Off	Enable/Disable the key signal as a pre-multiplied key
Clip	15%	0%~100%	Clip level adjusts the threshold at which the key cuts its hole. Decreasing the clip level reveals more of the background. If the background video is completely black then the clip value is too low.
Gain	50%	0%~100%	Gain modifies the softness of the key edge. Adjust the gain value until the edge softness is desirable but the background video luminance or brightness is not affected.
Invert	Off	On/Off	Enable/Disable the inverse to key source.
resize			
Resize	Off	On/Off	Enable/Disable luma keyer resize
Size	0.33	0.25/0.33/0.50	Set the relative size for luma keyer
X Position	10.6	-16.0~16.0	Set the starting X-coordinate
Y Position	6	-9.0~9.0	Set the starting Y-coordinate

- Select fill source and key source for luma key by setting **Luma Key → Source** menu item, and adjust the mask area by **Luma Key → Mask**, adjust the Pre multiplied Key parameters by **Luma Key → Control**.

- If performing a luma key, select the same source for both fill and key source.
- Refer to "4.1.3.11 Set Luma Key or Linear key" for the description about luma key and linear key.

5.1.5 Chroma KEY Settings

Set chroma key as an upstream keyer to button **KEY**, and set its parameters in this menu, the menu items are as shown in Figure 5.1-7:

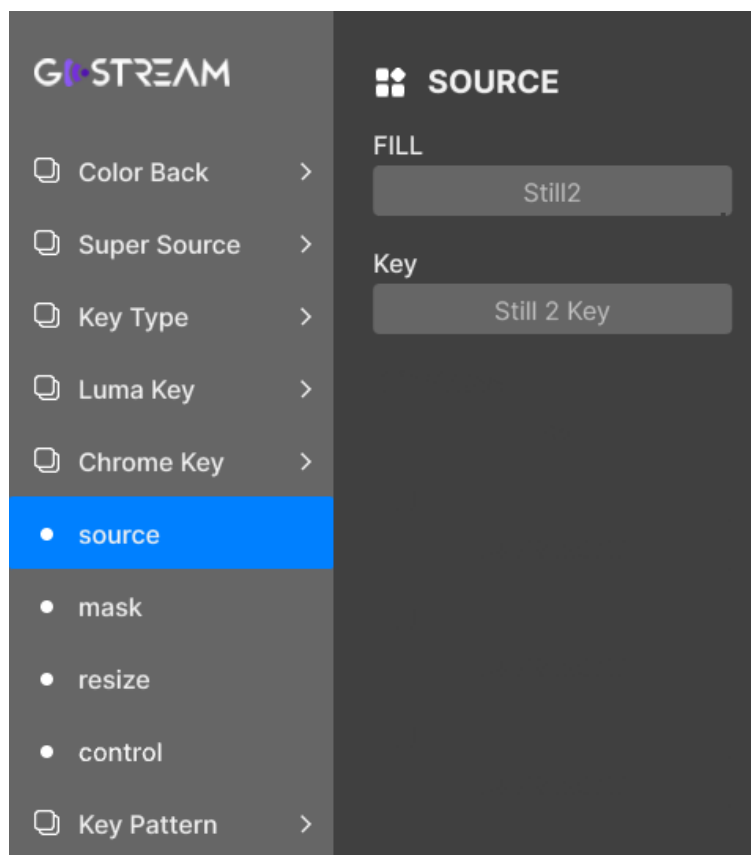

Figure 5.1-7 Chrome Key Menu

The relationship of Items, Default Value, Domain Range and Description of the sub-item is shown in Table 5.1-5:

Table 5.1-5 Description of Chrome Menu Items

Items	Default	Domain Range	Description
source			
Fill	Still 2	In 1/In 2/In 3/In 4/Aux/	Set the fill source

Items	Default	Domain Range	Description
		Still 1/Still 1 Key/ Still 2/Still 2 Key/ Color 1/Color 2/ Color Bar/Black	
mask			
Mask	Off	On/Off	Enable/Disable mask
H Start	0%	0%~100%	Set the starting X-coordinate for mask
V Start	0%	0%~100%	Set the starting Y-coordinate for mask
H End	100%	0%~100%	Set the ending X-coordinate for mask
V End	100%	0%~100%	Set the ending Y-coordinate for mask
resize			
Resize	Off	On/Off	Enable/Disable chrome keyer resize
Size	0.33	0.25/0.33/0.50	Set the relative size for chrome keyer
X position	10.6	-16.0~16.0	Set the starting X-coordinate
Y position	6.0	-9.0~9.0	Set the starting Y-coordinate
control			
SMP Position X	14.0	-16.0~16.0	Set the X-coordinate for the sample cursor
SMP Position Y	7.0	-9.0~9.0	Set the Y-coordinate for the sample cursor
Sample	Off	On/Off	Enable/Disable customized sample. Enable this item, you'll see a box cursor. This cursor will indicate the sample area on the fill source.
Current Color	---	---	Display the color sample
Foreground	0%	0~100%	Set the transparency of the foreground layer
Background	0%	0~100%	Set the transparency of the background layer
KeyEdge	50%	0~100%	Set the transparency of the chroma key's edge

■ **Sample Cursor**

To assign a sample color, enable the sample cursor at first, then set the X-coordinate and Y-coordinate to move the cursor to your desired position where you will get your sample color.

Select **Chroma Key**→**Control** →**Sample** item as **On**, then the fill source will display in PVW window, and it will display a sample box as the sample cursor on the key source, as shown in Figure 5.1-8, to refine the selection area for chroma key, you can adjust **SMP X Position** and **SMP Y Position** items to move the sample cursor. Then set **Foreground**, **Background** and **KeyEdge** items to refine the blended selection area, your foreground elements should be cleanly separated from the background.



Figure 5.1-8 Sample Cursor

Tips

- Refer to "4.1.3.12 Set Chroma Key" for more details about the chroma keyer.
- When sampling on screen, we recommend sampling the darkest area first to give you a more accurate key.
- **About sample color:** When sampling on screen, you should set **Chroma Key**→**control**→**Sample** as **Enable**. After getting your sample color, make sure you will set **Chroma Key**→**control**→**Sample** as **Disable** to shut down the color sampling in order to close the sample image which is on the top layer. The default sample color is green (0,255,0)(RGB).

5.1.6 Key Pattern Settings

Set pattern key as an upstream keyer to button **KEY**, and set its parameters in this menu, the menu items are as shown in Figure 5.1-9:

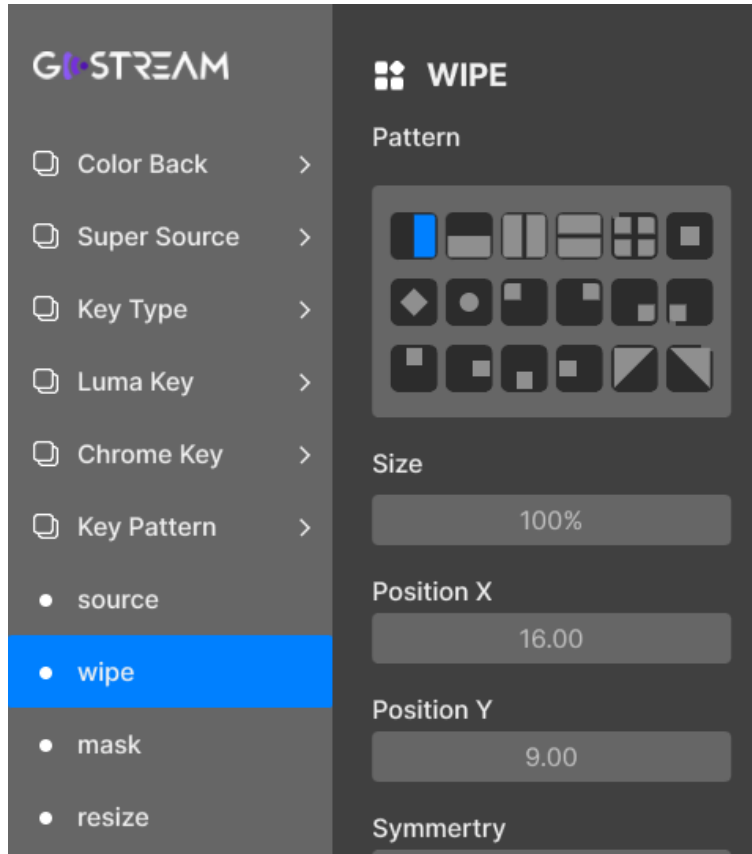

Figure 5.1-9 Key Pattern Menu

The relationship of Items, Default Value, Domain Range and Description of the sub-item is shown in Table 5.1-6:

Table 5.1-6 Description of Key Pattern Menu Items

Items	Default	Domain Range	Description
source			
Fill	Still 2	In 1/In 2/In 3/In 4/Aux/ Still 1/Still 1 Key/ Still 2/Still 2 Key/ Color 1/Color 2/ Color Bar/Black	Set fill source for pattern
wipe			
Pattern	--	As shown in Table 5.1-7	Set the pattern style
Size	100%	1%~100%	Set the size for the selected pattern
Position X	-16.00	-16.00~16.00	Set the central X-coordinate for pattern
Position Y	-9.00	-9.00~9.00	Set the central Y-coordinate for pattern
Symmetry	50%	0~100%	Set ratio of width to height

Items	Default	Domain Range	Description
Softness	0%	0~100%	Set the softness for pattern edge
mask			
Enable	Off	On/Off	Enable/Disable mask
H Start	0%	0%~100%	Set the starting X-coordinate for mask
V Start	0%	0%~100%	Set the starting Y-coordinate for mask
H End	100%	0%~100%	Set the ending X-coordinate for mask
V End	100%	0%~100%	Set the ending Y-coordinate for mask
resize			
Resize	Off	On/Off	Enable/Disable pattern resize
Size	0.33	0.25/0.33/0.50	Set the relative size for pattern, this setting will decrease the selected pattern to a desired size.
X Position	16.0	-16.0~16.0, 0.1 step	Set the starting X-coordinate
Y Position	9.0	-9.0~9.0, 0.1 step	Set the starting Y-coordinate

■ **Pattern:**

We provide 18 shapes by the internal pattern generator, as shown in Table 5.1-7.

Table 5.1-7 Pattern Icons for Wipe

Icon	Description	Icon	Description
	Horizontal Wipe-left to right		Rectangle Wipe-from top right
	Vertical Wipe-up to down		Rectangle Wipe-from bottom right
	Horizontal Wipe- right to left		Rectangle Wipe-from bottom left
	Vertical Wipe- down to up		Rectangle Wipe-from top center
	Surround Wipe		Rectangle Wipe-from right center
	Rectangle Wipe		Rectangle Wipe-from bottom center
	Diamond Wipe		Rectangle Wipe-from left center

Icon	Description	Icon	Description
	Circle Wipe		Diagonal Wipe
	Rectangle Wipe-from top left		Diagonal Wipe

i Tips

- Refer to "5.1.3 Key Type Settings" to assign Key Pattern as upstream keyer on KEY button.
- Refer to "4.1.3.13 Set Pattern Key" for more details about Key Pattern operation.

5.1.7 PIP Settings

Set PIP key as an upstream keyer to button **KEY**, this menu is used to create picture-in-picture box with borders. Set its parameters in this menu, the menu items are as shown in Figure 5.1-10:

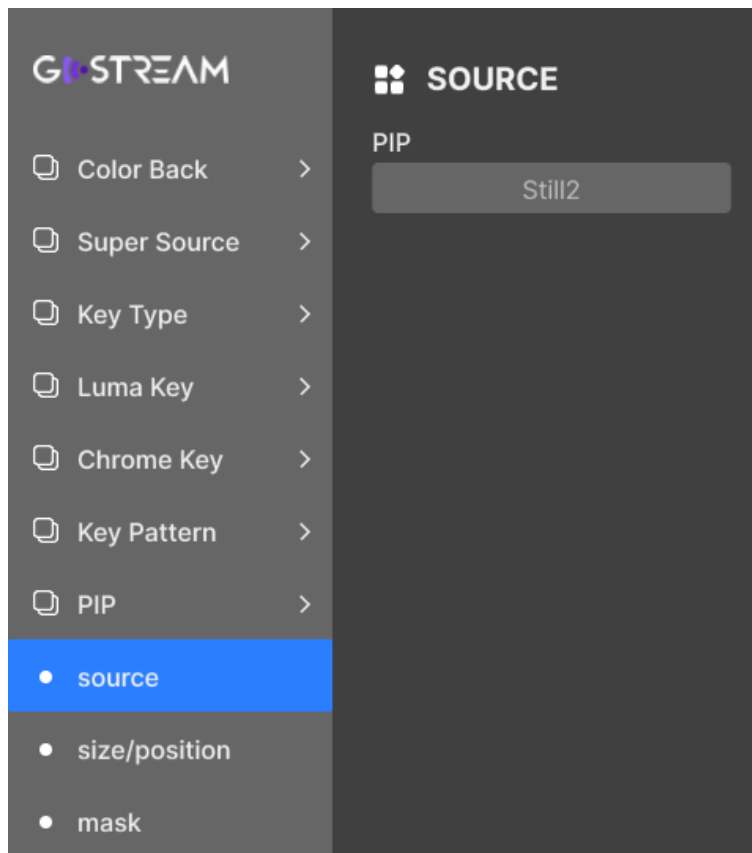

Figure 5.1-10 PIP Menu

The relationship of Items, Default Value, Domain Range and Description of the sub-item is shown in Table 5.1-8:

Table 5.1-8 Description of PIP Menu Items

Items	Default	Domain Range	Description
source			
PIP	In1	In 1/In 2/In 3/In 4/Aux/ Still 1/Still 1 Key/ Still 2/Still 2 Key/ Color 1/Color 2/ Color Bar/Black	Set PIP source
size/position			
Pip size	0.33	0.25/0.33/0.50	Set the size for the PIP subview
X Position	10.6	-16.0~16.0, 0.2 step	Set the starting X-coordinate for PIP view
Y Position	6.0	-9.0~9.0, 0.2 step	Set the starting Y-coordinate for PIP view
mask			
Enable	Off	On, Off	Enable/Disable mask
H start	0%	0%~100%	Set the starting X-coordinate for mask
V start	0%	0%~100%	Set the starting Y-coordinate for mask
H End	100%	0%~100%	Set the ending X-coordinate for mask
V End	100%	0%~100%	Set the ending Y-coordinate for mask
border			
Enable	Off	On, Off	Enable/Disable the border display for PIP view
Width	0	0~31	Set the width for the border
color			
Hue	0	0~359	Set the hue for border color
Saturation	100%	0%~100%	Set the saturation for border color
Brightness	100%	0%~100%	Set the brightness for border color
Current Color	---	---	Display the color sample

■ **PIP Key**

Use this menu to create picture-in-picture box with borders, the layer relationship

of the fill source and background source are as shown in Figure 5.1-11:



Figure 5.1-11 PIP Illustration

■ **PIP size**

Set the size for the subview window by **PIP → size/position → PIP size**;

■ **PIP Position**

Set the position for the subview window by **PIP → size/position → X position/ Y position**.

i Tips

- Refer to "5.1.3 Key Type Settings" to assign PIP as upstream keyer on KEY button.
- Refer to "4.1.3.14 Set PIP Key" for more details about PIP operation.

5.1.8 Transition Settings

You can configure the parameters of each transition style, including MIX, DIP and WIPE, the menu items are as shown in Figure 5.1-12:

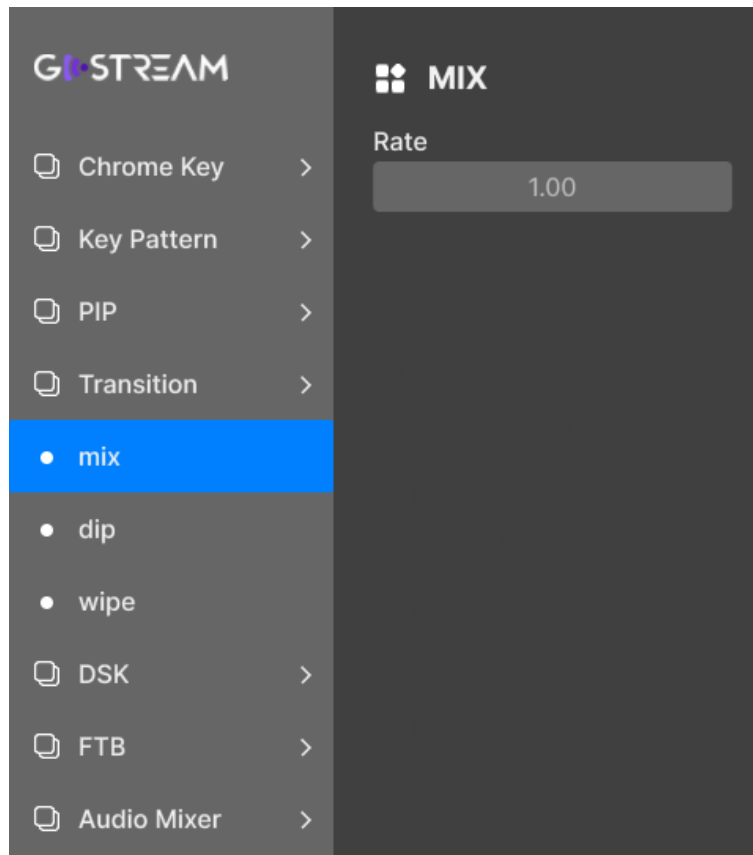



Figure 5.1-12 Transition Menu

The relationship of Items, Default Value, Domain Range and Description of the sub-item is shown in Table 5.1-9:

Table 5.1-9 Description of Transition Menu Items

Items	Default	Domain Range	Description
mix			
Rate	1.00	0.00~8.00s	Set the duration for mix transition
dip			
Source	Color 1	In 1/In 2/In 3/In 4/Aux/ Still 1/Still 2/ Color 1/Color 2/ Color Bar/Black	Set the dip source, that is the third source during the dip gradual transition.
Rate	1.00	0.00~8.00s	Set the duration for dip transition
wipe			
Pattern	--	As shown in Table 5.1-7	Set wipe pattern
Rate	1.00	0.00~8.00	Set the duration for wipe transition

Items	Default	Domain Range	Description
X Position	0.00	-16.00~16.00	Set the central X-coordinate for pattern
Y Position	0.00	-9.00~9.00	Set the central Y-coordinate for pattern
Direction	Normal	Normal: from center to edge Inverse: from edge to center	Set the direction for wipe transition
Symmetry	50%	0~100%	Set ratio of width to height
Softness	0%	0~100%	Set the softness for pattern edge
Border	0%	0~100%	Set the width for the border
Border Source	Color 1	In 1/In 2/In 3/In 4/Aux/ Still 1/Still 2/ Color 1/Color 2/ Color Bar/Black	Set border source in wipe transition

- If you want to show a perfect circle or square when selecting the wipe pattern as square  or circle , set the **Symmetry** item to be 81%.
- Refer to "4.1.2.8 Transition Control" about more details about effect transition.
- Take a dip transition for example, refer to "4.1.3.4 Switching Sources Using an Auto Transition" for more details about the operations.
- If you select the DIP transition (Press **DIP** button down), and you have saved a stinger file named as **stingersource.mp4** to the videos folder in SD card, this unit will load this video in the dip transition.

5.1.9 DSK Settings

You can configure the parameters of downstream keyer, including source, mask, control and rate, the menu items are as shown in Figure 5.1-13:

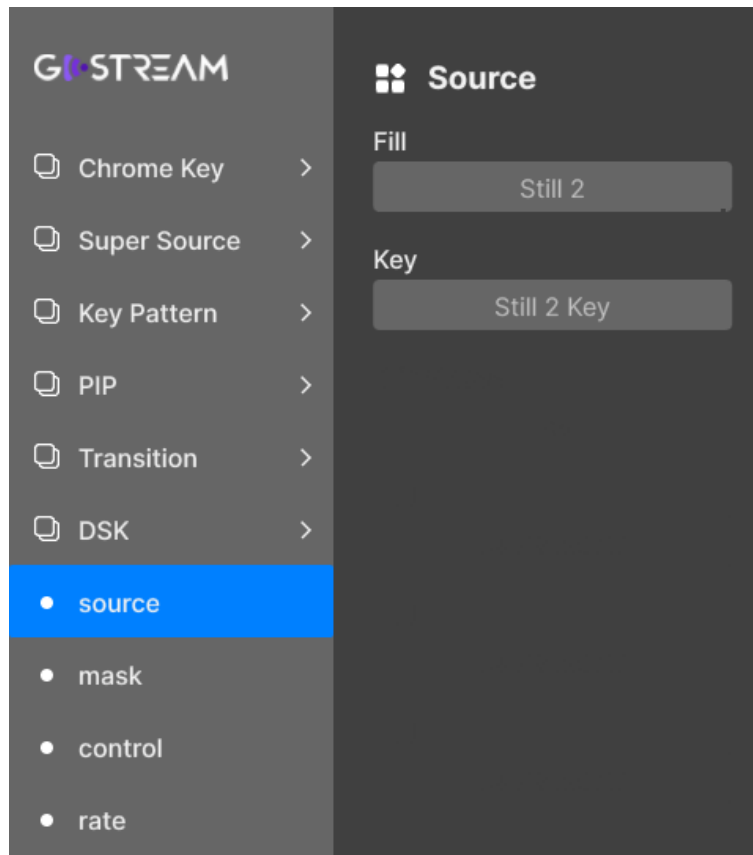

Figure 5.1-13 DSK Menu

The relationship of Items, Default Value, Domain Range and Description of the sub-item is shown in Table 5.1-10:

Table 5.1-10 Description of DSK Menu Items

Items	Default	Domain Range	Description
source			
Fill	Still 2	In 1/In 2/In 3/In 4/Aux/ Still 1/Still 1 Key/ Still 2/Still 2 Key/ Color 1/Color 2/ Color Bar/Black	Set the fill source
Key	Still 2 Key	In 1/In 2/In 3/In 4/Aux/ Still 1/Still 1 Key/ Still 2/Still 2 Key/ Color 1/Color 2/ Color Bar/Black	Set the key source
mask			
Enable	Off	On/Off	Enable/Disable mask

Items	Default	Domain Range	Description
H Start	0%	0%~100%	Set the starting X-coordinate for mask
V Start	0%	0%~100%	Set the starting Y-coordinate for mask
H End	100%	0%~100%	Set the ending X-coordinate for mask
V End	100%	0%~100%	Set the ending Y-coordinate for mask
control			
Shaped Key	Off	On/Off	Enable/Disable the key signal as a pre-multiplied key
Clip	15%	0%~100%	Clip level adjusts the threshold at which the key cuts its hole. Decreasing the clip level reveals more of the background. If the background video is completely black then the clip value is too low.
Gain	50%	0%~100%	Gain modifies the softness of the key edge. Adjust the gain value until the edge softness is desirable but the background video luminance or brightness is not affected.
Invert	Off	On/Off	Enable/Disable the inverse to key source.
rate			
Rate	1.0	0.0~8.0s, 0.5s step	Set the transition rate for downstream keyer

- Refer to "4.1.2.9 Next Transition" about more details about downstream keyer.
- Refer to "4.1.3.16 Perform Upstream/Downstream key Transition" for more details about the downstream keyer operation.

5.1.10 FTB Settings

FTB allows the operator to manually control the transition to fade to black, and

provides visual feedback on the progress of the transition. You can set the transition rate for FTB, and whether the audio is changing with video in this menu, the menu items are as shown in Figure 5.1-14:

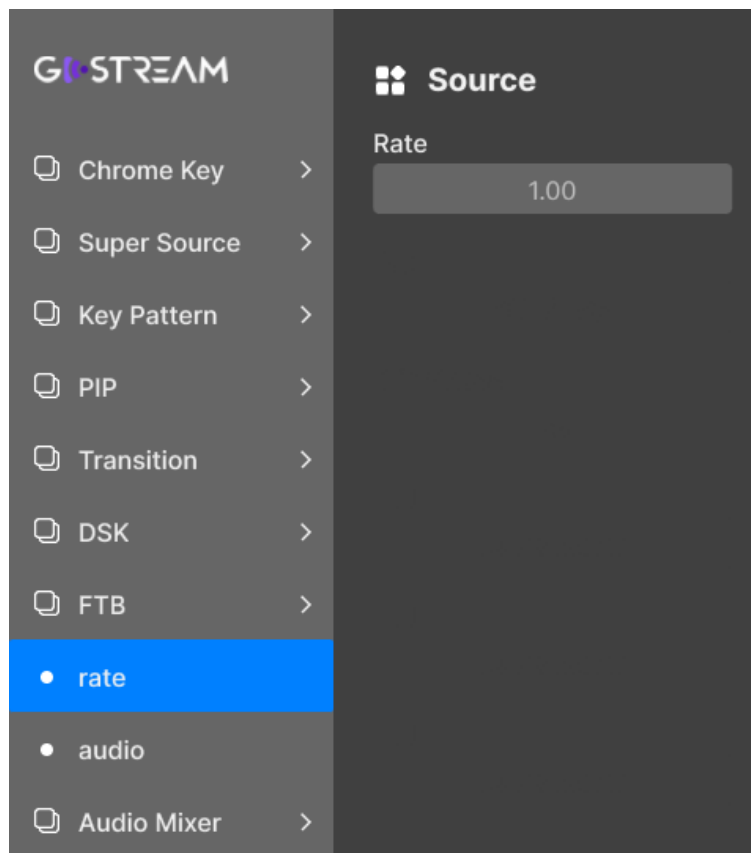

Figure 5.1-14 FTB Menu

The relationship of Items, Default Value, Domain Range and Description of the sub-item is shown in Table 5.1-11:

Table 5.1-11 Description of FTB Menu Items

Items	Default	Domain Range	Description
rate			
Rate	1.0s	0.0~8.0s, 0.5s step	Set the transition rate for fading to black
audio			
AFV	On	On: Enable the audio fading with FTB operation Off: audio will remain when executing FTB.	Enable/Disable the audio fading with fade to black operation



- Refer to "4.1.2.8 Transition Control" about more details about FTB transition.
- Refer to "4.1.3.5 Fade to Black" for more details about the FTB operation and the cooperation of FTB and AFV.

5.1.11 Audio Mixer Settings

This menu let you enhance and refine the quality of sound on each input and program output, including input level controls, equalizer and dynamics settings and so on. It provides the following audio channels, including **MIC1**, **MIC2**, **IN1**, **IN2**, **IN3**, **IN4**, **AUX**, **PGM** and **MONITOR**, the menu items are as shown in Figure 5.1-15:

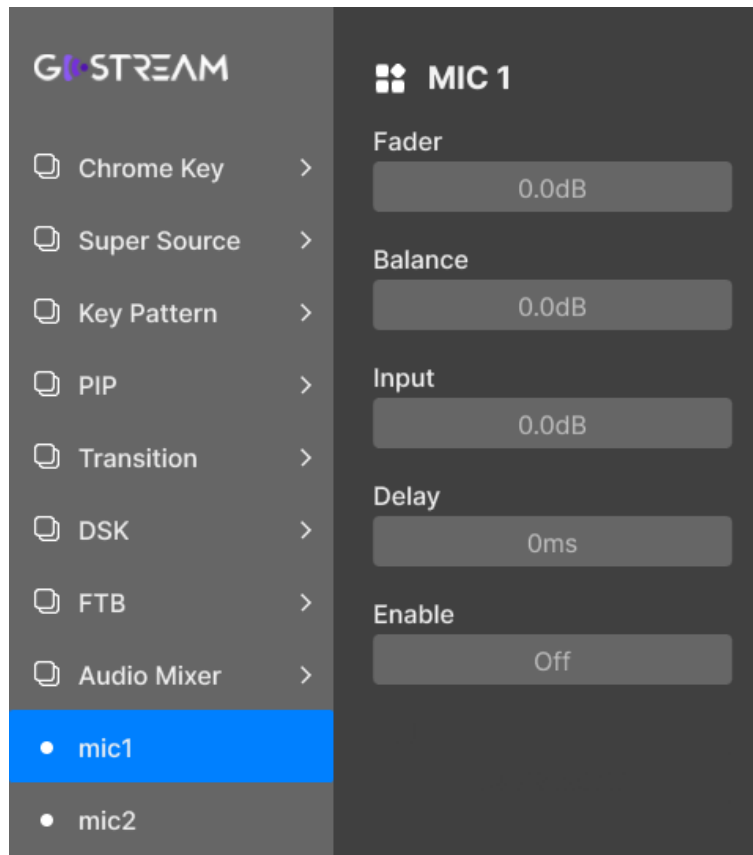

Figure 5.1-15 Audio Meter Menu

The relationship of Items, Default Value, Domain Range and Description of the sub-item is shown in Table 5.1-12:

Table 5.1-12 Description of Audio Meter Menu Items

Items	Default	Domain Range	Description
-------	---------	--------------	-------------

Items	Default	Domain Range	Description
mic 1			
Fader	0	+10.0~-75.0dB, 0.5dB step	Set the audio level for microphones connected to the MIC1 input
Balance	0	-40.0~+40.0dB	Change the audio channel balance for Mic1
Input	0	+6.0~-75.0dB	Set input level
Delay	0	0mS-400mS, 10mS step, 8K samples	Set delay for MIC1 output
Enable	Off	On: Enable MIC1 Off: Disable MIC1	Enable/Disable MIC1 audio channel
mic 2			
Fader	0	+10.0~-75.0dB	Set the audio level for microphones connected to the MIC2 input
Balance	0	-40.0~+40.0dB	Change the audio channel balance for Mic2
Input	0	+6.0~-75.0dB	Set input level
Delay	0	0mS-400mS, 10mS step, 8K samples, 400mS maxim	Set delay for MIC2 output
Enable	Off	On: Enable MIC2 Off: Disable MIC2	Enable/Disable MIC2 audio channel
In1			
Fader	0	+10.0~-75.0dB	Set IN1 levels for mix
Balance	0	-40.0~+40.0dB	Change the audio channel balance for IN1
Input	0	+6.0~-75.0dB	Set input level
Enable	Off	On: Enable IN1 Off: Disable IN1 AVF: audio follow video for IN1	Enable/Disable IN1 audio channel
In2			
Fader	0	+10.0~-75.0dB	Set IN2 levels for mix
Balance	0	-40.0~+40.0dB	Change the audio channel balance for IN2
Input	0	+6.0~-75.0dB	Set input level
Enable	Off	On: Enable IN2	Enable/Disable IN2 audio

Items	Default	Domain Range	Description
		Off: Disable IN2 AVF: audio follow video for IN2	channel
In3			
Fader	0	+10.0~-75.0dB	Set IN3 levels for mix
Balance	0	-40.0~+40.0dB	Change the audio channel balance for IN3
Input	0	+6.0~-75.0dB	Set input level
Enable	Off	On: Enable IN3 Off: Disable IN3 AVF: audio follow video for IN3	Enable/Disable IN3 audio channel
In4			
Fader	0	+10.0~-75.0dB	Set IN4 levels for mix
Balance	0	-40.0~+40.0dB	Change the audio channel balance for IN4
Input	0	+6.0~-75.0dB	Set input level
Enable	Off	On: Enable IN4 Off: Disable IN4 AVF: audio follow video for IN4	Enable/Disable IN4 audio channel
aux			
Fader	0	+10.0~-75.0dB	Set AUX levels for mix
Balance	0	-40.0~+40.0dB	Change the audio channel balance for AUX
Input	0	+6.0~-75.0dB	Set input level
Enable	Off	On: Enable AUX Off: Disable AUX AVF: audio follow video for AUX	Enable/Disable AUX audio channel
PGM			
Fader	0	+10.0~-75.0dB	Set program audio output level
monitor			
Level	-6	0~-31dB	Set output level for earphone interface
Source	PGM	In 1/In 2/In 3/In 4/ Aux/Mic 1/Mic 2/PGM	Select audio source for monitoring

Items	Default	Domain Range	Description
common			
Audio Switching	Hard Cut	Hard Cut/Switch with effect	Set the audio switching mode. Only available in AFV mode.

■ **Input Level**

Input item is used to adjust the input level for each audio source.

Generally, when setting up audio mix, the first step is to normalize all your inputs. This means adjusting the input level for each input so you can optimize all the levels to their highest strength without clipping.

After setting the input level, all the inputs will have a common signal strength so they are all at their strongest without clipping.

After normalized all your input levels, you can use balance item to optimize and shape the quality for each audio input.

■ **Balance**

Select **Audio Mixer**→ **audio channel**→ **balance** item to adjust balance.

If you wish to change the left and right audio channel balance for an audio source, adjust the balance item to the desired balance point.

■ **Enable/Disable Audio Source**

You can control the audio source whether to mix into the audio output by setting the **Enable** item. Any one of the 7 audio sources has its own Enable switcher, the value range is as below:

- Enable=ON: turn on this audio channel. This channel will be mixed into the mixed audio output although its video is not the program output.
- Enable=OFF: turn off this audio channel.
- Enable=AFV, audio follow video. Set the audio mixer to fade the audio with your video fade to black by selecting this value.

■ **Delay**

Delay item is used for analog audio via MIC1 and MIC2 to synchronize with video.

When using analog audio via MIC inputs, there may be a slight difference in the sync between analog audio and video.

Setting the audio delay by setting **Audio Mixer**→ **MIC1/ MIC2**→ **delay** item will ensure the analog audio input is perfectly synced with the video inputs.

i Tips

- MIC1 and MIC2 have no AFV option.
- You can monitor the program audio output or other sources by **PHONE** interface, set this by selecting **Audio Mixer→monitor→Source** item, and adjust its level by **Audio Mixer→monitor→level** item.
- Refer to "4.1.3.18 How to Use Audio Mixer" for details about audio mixer.
- The **Audio Mixer→common→Audio switching** item is only available in AFV mode.

5.1.12 Still Generator Settings

You can use this menu to choose an image slot, upload images, and set images for button Still1 and Still2, the menu items are as shown in Figure 5.1-16:

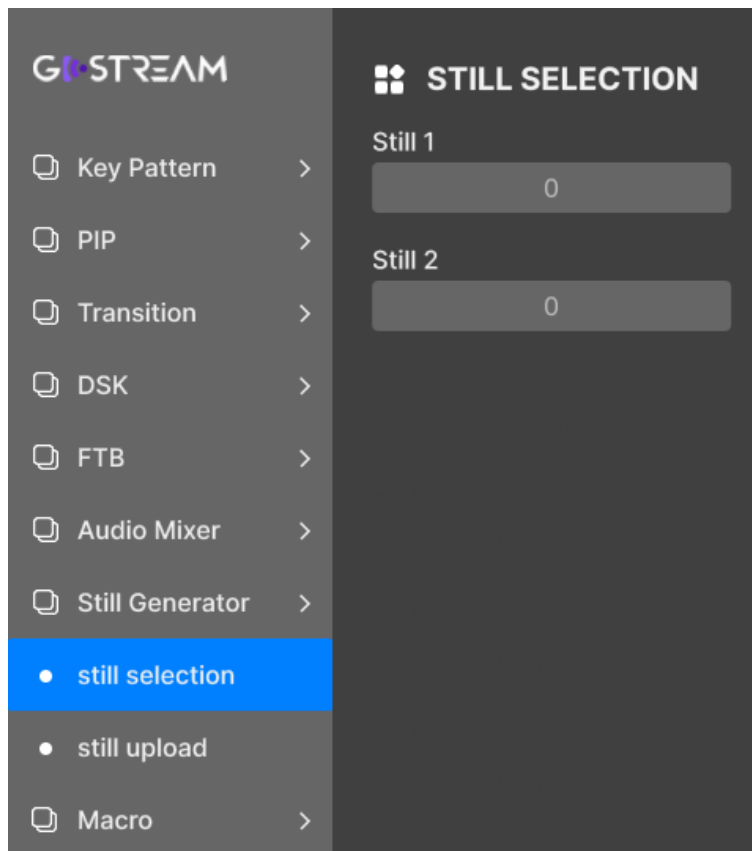

Figure 5.1-16 Still Generator Menu

The relationship of Items, Default Value, Domain Range and Description of the sub-item is shown in Table 5.1-13:

Table 5.1-13 Description of Still Generator Menu Items

Items	Default	Domain Range	Description
still selection			
still 1	0	0~31	Select a location ID for Still1
still 2	0	0~31	Select a location ID for Still2
still upload			
location	0	0~31	Select a location ID for uploading a still image
load picture	--	Select a file	Select an image from SD card in "images" folder, and the file's suffix should be ".png"

5.1.13 Macro Settings

You can set the sleep time between every two macro commands, the menu item is as shown in Figure 5.1-17:

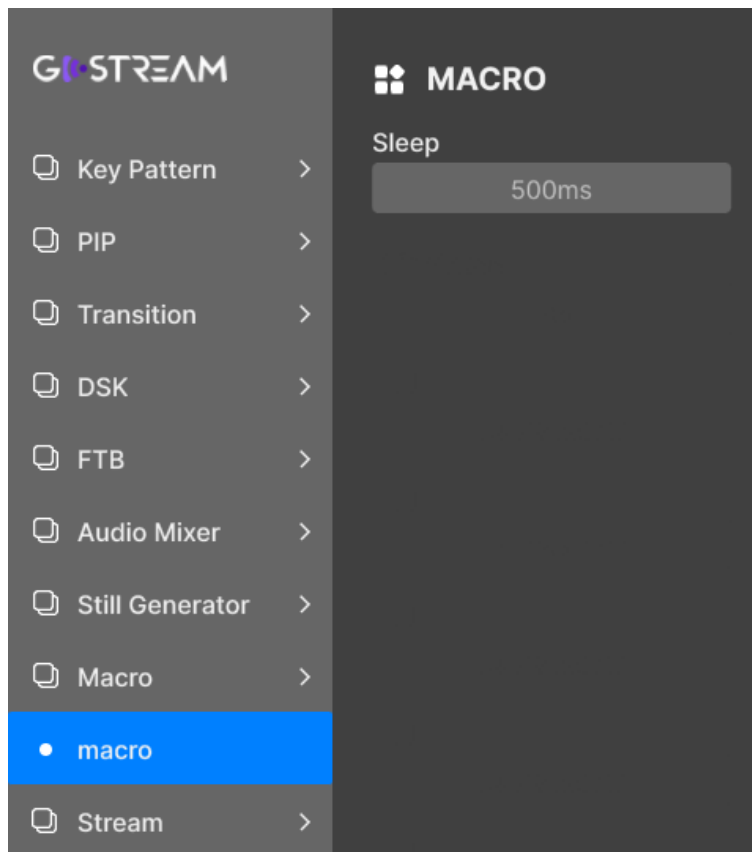

Figure 5.1-17 Macro Menu

The relationship of Items, Default Value, Domain Range and Description of the sub-item is shown in Table 5.1-14:

Table 5.1-14 Description of Macro Menu Items

Items	Default	Domain Range	Description
macro			
Sleep	500ms	0~10000ms	Set sleep time between every two macro commands.

 **Tips**

- Refer to "4.1.3.19 How to Record and Run" for details about macro.
- The macro commands are saved in the profile.xml file in SD card.

5.1.14 Stream Settings

You can choose which platform you want to use and set all the relevant settings for your stream, including platform, server, key and output, the menu items are as shown in Figure 5.1-18.

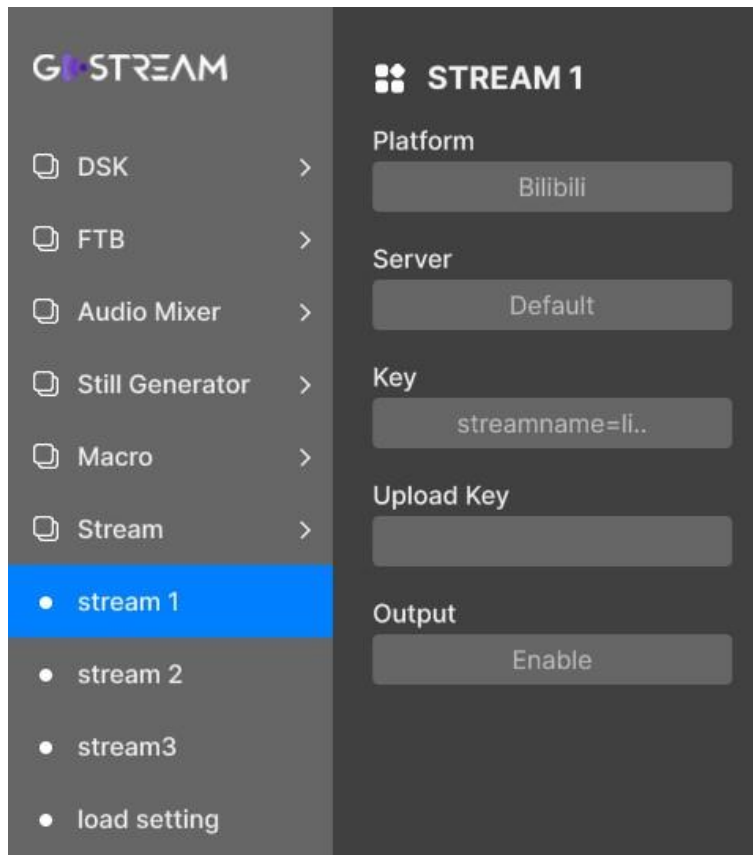

Figure 5.1-18 Stream Menu

The relationship of Items, Default Value, Domain Range and Description of the sub-item is shown in Table 5.1-15:

Table 5.1-15 Description of Stream Menu Items

Items	Default	Domain Range	Description
stream1			
Platform	Bilibili	FaceBook/Twitch/YouTube/ Twitter/Restream.IO/Vimeo/ BoxCast/Castr/AfreecaTV/ Bilibili/DouYu/Weibo	Select a platform to live
Server	Default	Default /---	Select a server
Key	---	---	Enter a key
Upload Key	---	---	Select a file to upload a key. You should copy your key characters to a "*. txt " file in SD card. This will be very helpful when you have lots of keys, and you can save every key into a independent INI file.

Items	Default	Domain Range	Description
Output	Disable	Enable/Disable	Enable/Disable stream1
stream2			
Platform	--	FaceBook/Twitch/YouTube/ Twitter/Restream.IO/Vimeo/ BoxCast/Castr/AfreecaTV/ Bilibili/DouYu/Weibo	Select a platform to live
Server	---	---	Select a server
Key	---	---	Enter a key
Upload Key	---	---	Select a file to upload a key. You should copy your key characters to a "*.txt" file in SD card. This will be very helpful when you have lots of keys, and you can save every key into a independent INI file.
Output	Disable	Enable/Disable	Enable/Disable stream2
stream3			
Platform	--	FaceBook/Twitch/YouTube/ Twitter/Restream.IO/Vimeo/ BoxCast/Castr/AfreecaTV/ Bilibili/DouYu/Weibo	Select a platform to live
Server	---	---	Select a server
Key	---	---	Enter a key
Upload Key	---	---	Select a file to upload a key. You should copy your key characters to a "*.txt" file in SD card. This will be very helpful when you have lots of keys, and you can save every key into a independent INI file.
Output	Disable	Enable/Disable	Enable/Disable stream3
load setting			
Load	---	---	Load a customized live stream platform information to this unit.
Restore Defaults	---	---	Restore the default settings for streaming platform.

1. Load customized platform information

You can define a customized platform by add the corresponding segment to the

streaming.xml file in SD card.

Open the streaming.xml file in the stream_setting folder of SD card. Add a customized platform by adding a name and RTMP URL segment according to the annotation information provided in this file. Refer to streaming.xml for the details. After that, save this modification and reinsert the SD card to this unit. Select **Stream**→ **load setting**→**Load** command to read the customized platform information to the **Platform** item.

Then, you can read this platform which you have just uploaded to the current unit.

2. Get your stream key

When streaming, YouTube Live, bilibili Live or other platform will assign a key for your stream.

For example: Take YouTube Live for example, create the Key as below:

Step 1 Logo into your YouTube account.

Step 2 Create Stream Key

Navigate to the 'video/live' option and click 'get started', then select 'stream' options, enter your broadcast details and click 'create stream'. An auto generated stream key will appear.

Step 3 Copy Stream Key

Click 'copy' to copy the stream key.

Step 4 Save Stream Key

At last, save your stream key into a TXT file, then copy and paste this file to the stream_key folder of your SD card.

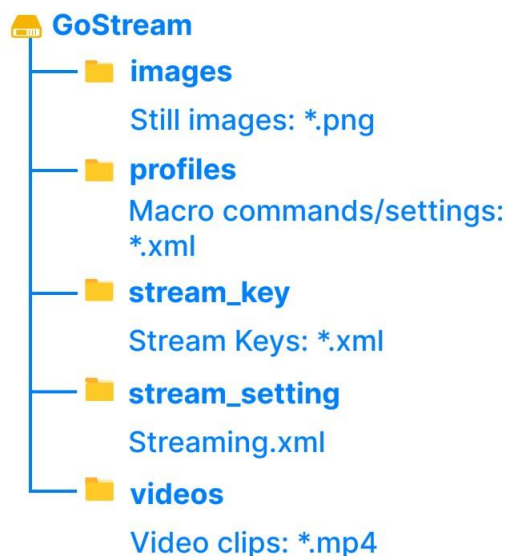

Figure 5.1-19 Directory Tree in SD Card

i Tips

- Please make sure that your stream key file is located in the "stream_key" folder of SD card, not the root directory of SD card! Refer to "4.2.2 Rear Connectors Operations" for details about **SD** card used in your GoStream.

3. Input Stream Key for Stream

After getting the stream key provided by platform, you should input this key into the switcher by two methods, by manual input or uploading from a key file of SD card.

■ **Method 1: Manual input**

Input the stream key by setting **Stream→ Stream*→Key** item, and input the characters in the popup software keyboard, as shown in Figure 5.1-20:

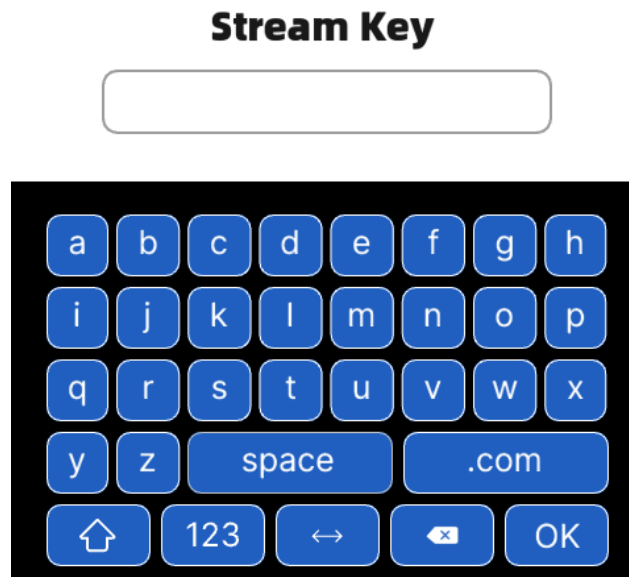

Figure 5.1-20 Software Keyboard for Stream Key

■ **Method2: upload from a file**

You can save your stream key in a text file, and the suffix of the file must be ".txt". Load this key by **Stream→ Stream*→Upload Key** item.

4. Stream Status

- The stream button's indicators have various status: Stream Button's Color:

There are four statuses for stream buttons to indicating the live status.

- **Red highlight:** normal streaming and communication;
- **Yellow highlight:** normal communication, but data abnormal;
- **Yellow Flash:** no communication;
- **Gray:** no streaming.

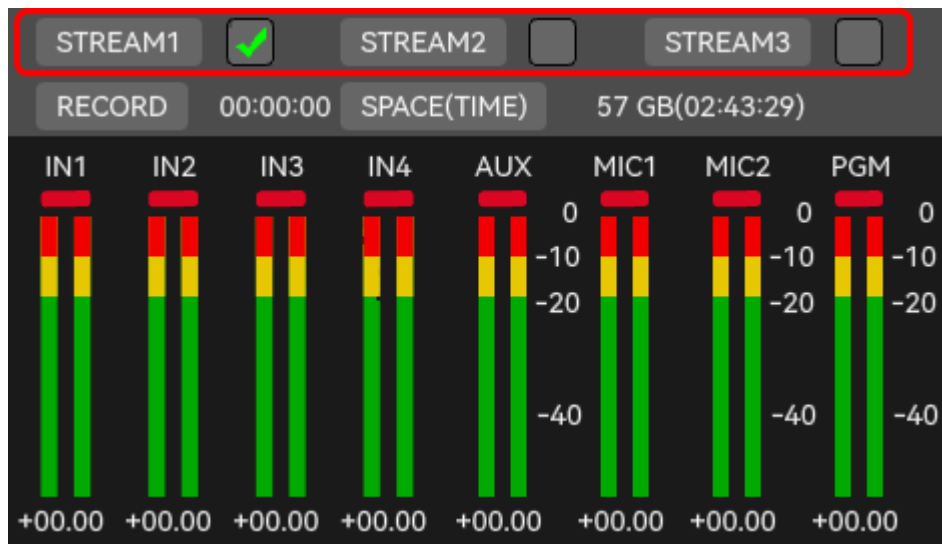

Figure 5.1-21 Streaming View

5. Streaming Rate

The data rate used by the quality setting will change depending on the video standard your switcher is running at, and it could be set as **Low**, **Medium** or **High**.

Set the streaming rate by **Setting**→**quality**→**Streaming** item, and set the output video standard by **Setting**→**output format**→**Format** item.

For example: if you select high streaming quality and are running at 1080p30 then it would use the 6 Mb/s data rate, you can check this in Table 5.1-19.

Tips

- Refer to "5.1.16.1Set Recording & Streaming Quality" for details about **Streaming Rate** and **output format** setting.

5.1.15 PlayBack Settings

You can set the playback parameters for the recorder files in SD card, the menu item

is as shown in Figure 5.1-22:

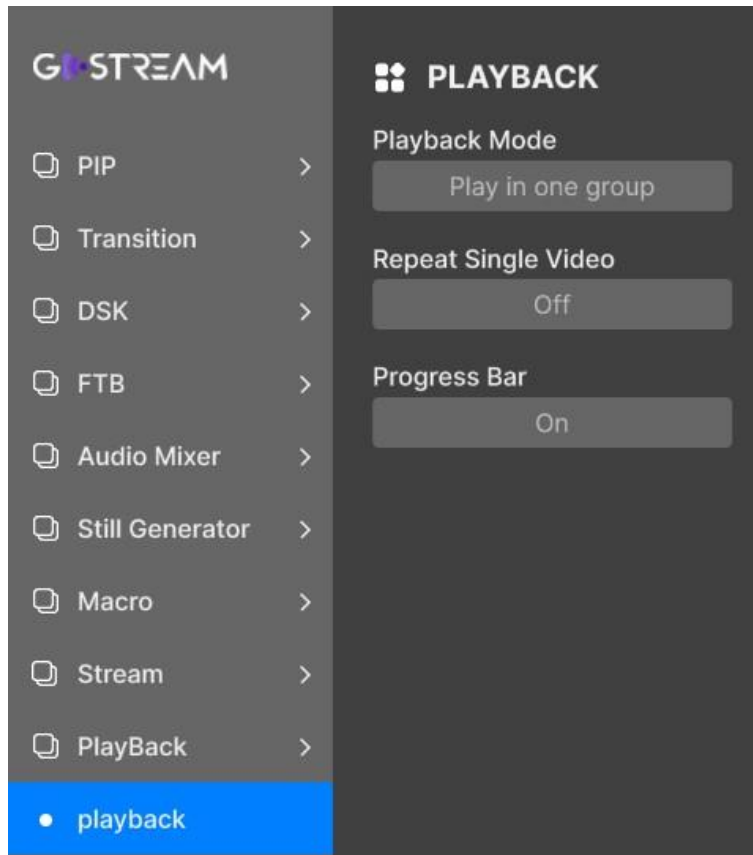

Figure 5.1-22 Playback Menu

The relationship of Items, Default Value, Domain Range and Description of the sub-item is shown in Table 5.1-16:

Table 5.1-16 Description of PlayBack Menu Items

Items	Default	Domain Range	Description
playback			
Playback Mode	Play in one group	Play in one group Play cross groups	Set the play mode for the videos recorded in your SD card.
Repeat Single Video	Off	On/Off	Play the current video in single cycle or not.
Progress Bar	On	On/Off	Enable/Disable the Progress Bar

i Tips

- You can choose a record file from the playback files list, refer to "4.1.3.21 How to Record and Play a Stream" for details about recorded video files saved in your SD

card, playback mode and progress bar and so on.

5.1.16 System Settings

Set system settings, including version, src name, mv meter, mv layout, mic input, record file, src selection, out format, etc. The menu items are as shown in Figure 5.1-23.

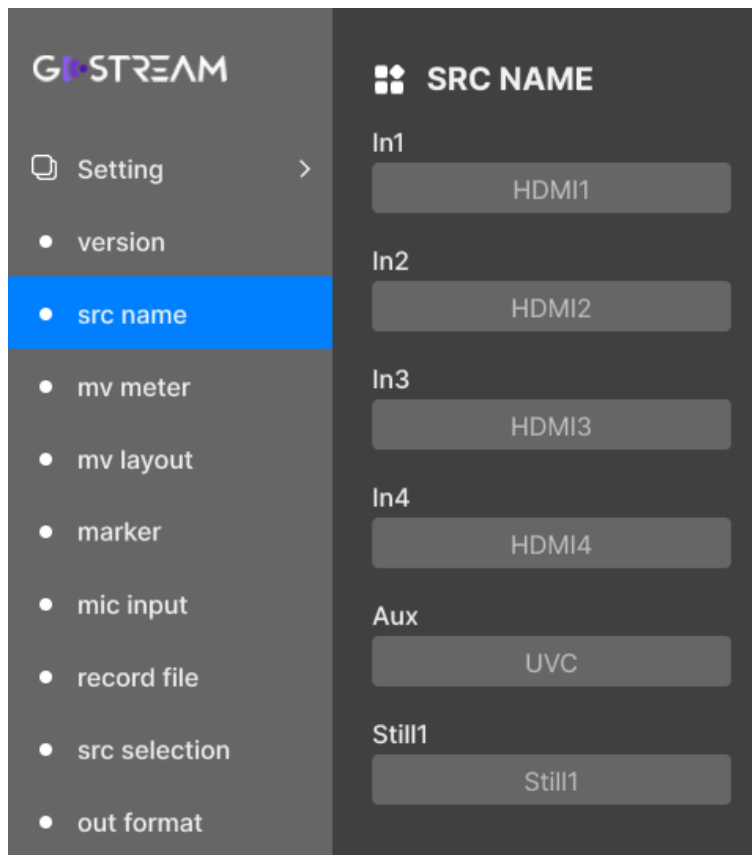

Figure 5.1-23 Setting Menu

The relationship of Items, Default Value, Domain Range and Description of the sub-item is shown in Table 5.1-17:

Table 5.1-17 Description of Setting Menu Items

Items	Default	Domain Range	Description
version			
Version	---	---	Show version
Build info	---	---	Show build info

Items	Default	Domain Range	Description
Device Info	---	---	Show device Info
src name			
PGM	Program	---	Add UMD for program view
PVW	Preview	---	Add UMD for preview view
In1	IN1	---	Add UMD for IN1 view
In2	IN2	---	Add UMD for IN2 view
In3	IN3	---	Add UMD for IN3 view
In4	IN4	---	Add UMD for IN4 view
Aux	AUX	---	Add UMD for AUX view
Still1	Still1	---	Add UMD for Still1 view
Still2	Still2	---	Add UMD for Still2 view
mv meter			
PGM	Off	On/Off	Enable/Disable audio meter in PGM view
In1	Off	On/Off	Enable/Disable audio meter in In1 view
In2	Off	On/Off	Enable/Disable audio meter in In2 view
In3	Off	On/Off	Enable/Disable audio meter in In3 view
In4	Off	On/Off	Enable/Disable audio meter in In4 view
Aux	Off	On/Off	Enable/Disable audio meter in Aux view
mv layout			
PGM/PVW SWAP	PVW PGM	PGM PVW PVW PGM	Swap the position of the multiview program and preview views
marker			
PVW	Off	On/Off	Enable/Disable the safe area marker inside the preview view. The outer marker represents the 16:9 safe area and the inner represents the 4:3 safe area.
mic input			
Mic 1 Input	Line	Mic+power: passive MIC plus power	Change the input signal type for MIC1 interface, the default is

Items	Default	Domain Range	Description
		Mic: active MIC Line: line level	"Mic+power"
Mic 2 Input	Line	Mic: active MIC Line: line level	Change the input signal type for MIC2 interface, the default is "Mic+power"
record file			
File Name	--	--	Set a name for the recording file in SD card
src selection			
In1	HDMI Auto	SDI, HDMI Auto, HDMI RGB Full, HDIM RGB Limit, HDMI YC422 Full, HDMI YC422 Limit, HDMI YC444 Full, HDMI YC444 Limit	Set signal type for IN1
In2	HDMI Auto	SDI, HDMI Auto, HDMI RGB Full, HDIM RGB Limit, HDMI YC422 Full, HDMI YC422 Limit, HDMI YC444 Full, HDMI YC444 Limit	Set signal type for IN2
In3	HDMI Auto	SDI, HDMI Auto, HDMI RGB Full, HDIM RGB Limit, HDMI YC422 Full, HDMI YC422 Limit, HDMI YC444 Full, HDMI YC444 Limit	Set signal type for IN3
In4	HDMI Auto	SDI, HDMI Auto, HDMI RGB Full, HDIM RGB Limit, HDMI YC422 Full, HDMI YC422 Limit, HDMI YC444 Full, HDMI YC444 Limit	Set signal type for IN4
Aux	SD card	UVC/SD card/ NDI	Set AUX source, from SD card, or camera connected with USB2, or smartphone camera through NDI WEBCAM
output format			

Items	Default	Domain Range	Description
Format	1080p60	1080p23.98, 1080p24, 1080p25, 1080p29.97, 1080p30, 1080p50, 1080p59.94, 1080p60	Set output resolution
Output1 Color Space	HDMI Auto	SDI, HDMI Auto, HDMI RGB Full, HDIM RGB Limit, HDMI YC422 Full, HDMI YC422 Limit, HDMI YC444 Full, HDMI YC444 Limit	Set color space for Output1
Output2 Color Space	HDMI Auto	SDI, HDMI Auto, HDMI RGB Full, HDIM RGB Limit, HDMI YC422 Full, HDMI YC422 Limit, HDMI YC444 Full, HDMI YC444 Limit	Set color space for Output2
out source			
HDMI 1	PGM	In 1/In 2/In 3/ In 4/Aux/ PGM/PVW/ Mulitview	Set HDMI1 output source (for OUT1)
HDMI 2	Mulitview	Mulitview	Check HDMI2 output source (for OUT2)
Streaming/ Recording/ UVC	PGM	In 1/In 2/In 3/ In 4/Aux/ PGM/PVW/ Mulitview	Set UVC output source (USB video class, recorded to SD card), this source is also played as current streaming, and you can record this source and save it to the Record_video folder in SD card.
quality			
Recording	Low	High/Medium/Low	Set the quality for recording
Streaming	Low	High/Medium/Low	Set the quality for streaming on live
network			
Protocol	--	DHCP/Static IP	Set network protocol
IP Address	--	172.20.2.212	Set IP address

Items	Default	Domain Range	Description
Subnet Mask	--	255.255.255.0	Set subnet mask
Gateway	--	255.255.255.0	Set gateway
Primary DNS	--	8.8.8.8	Set the primary DNS
Secondary DNS	--	8.8.4.4	Set the secondary DNS
light & fan			
Button Brightness	7	0~15	Set the brightness for panel buttons
profile			
Import	--	--	Import the configurations from the selected profile file in SD card. The default name of the corresponding file is profile***.xml.
Export	--	--	Export current settings to the Profile***.xml in SD card.
language			
Language	English	English/Chinese/Japanese	Set the system language
reset			
Factory Reset	--	--	Restore the factory settings
SD Format	--	--	Format SD card(Exfat format)

5.1.16.1 Set Recording & Streaming Quality

The quality values for recording and streaming are **Low**, **Medium** and **High**, the three items represent different rate depending on the video resolution your switcher is running at. The relationships are as shown in the following table:

The lower number is used for the lower frame rates of 30p, while the higher data rates are used when you are running higher frame rates of 60p.

■ Recording

Table 5.1-18 Recording Rate for Different Resolution

Item	Resolution	Bitrate (Mb/s)	Audio-bitrate
Low	720p30	1.5	128000
	720p60	2.25	128000

Item	Resolution	Bitrate (Mb/s)	Audio-bitrate
	1080p30	3	128000
	1080p60	4.5	128000
Medium	720p30	3	128000
	720p60	4.5	128000
	1080p30	8	128000
	1080p60	12	128000
High	720p30	4	128000
	720p60	6	128000
	1080p30	30	128000
	1080p60	50	128000

■ **Streaming**

For example, if you select Streaming High quality and are running at 1080p24 then it would use the 6 Mb/s data rate.

Table 5.1-19 Streaming Rate for Different Resolution

Item	Resolution	Bitrate (Mb/s)	Audio-bitrate
Low	720p30	1.5	128000
	720p60	2.25	128000
	1080p30	3	128000
	1080p60	4.5	128000
Medium	720p30	3	128000
	720p60	4.5	128000
	1080p30	4.5	128000
	1080p60	6	128000
High	720p30	4	128000
	720p60	6	128000
	1080p30	6	128000
	1080p60	9	128000

5.1.16.2 Set AUX Source

Set a source for AUX button by **Setting**→**src selection**→ **aux source**:

- SD card: video or image from SD card;
- UVC: camera connected with USB2.
- NDI: smartphone camera through NDI WEBCAM.

5.1.16.3 Set File Name for recording file

You can set a customized file name for the recording file in SD card.

Select **Setting**→**record file**→**File Name** item and enter your characters by the software keyboard, as shown in Figure 5.1-24. The file name is "FILENAME+ '_'+timestamp" by default, and the timestamp is the starting time of the recording for this file. The file suffix must be "*.mp4". You can leave the content of FILENAME item empty.

The video recorded will be saved automatically to the directory of "Video" folder, as "\video\file name.mp4".



Figure 5.1-24 Software Keyboard for File Name

5.1.16.4 Set Output Format

The switcher supports the following output format: 1080p24, 1080p25, 1080p30, 1080p50, 1080p60, 1080P23.98, 1080P29.97, 1080P59.94.

Select one by **Setting**→**output format**→ **Format** item.

5.1.16.5 Set Output Source

You can set the HDMI output source for OUT1, OUT2 and Streaming/Recording/UVC. When selected, the HDMI outputs and UVC will change immediately.

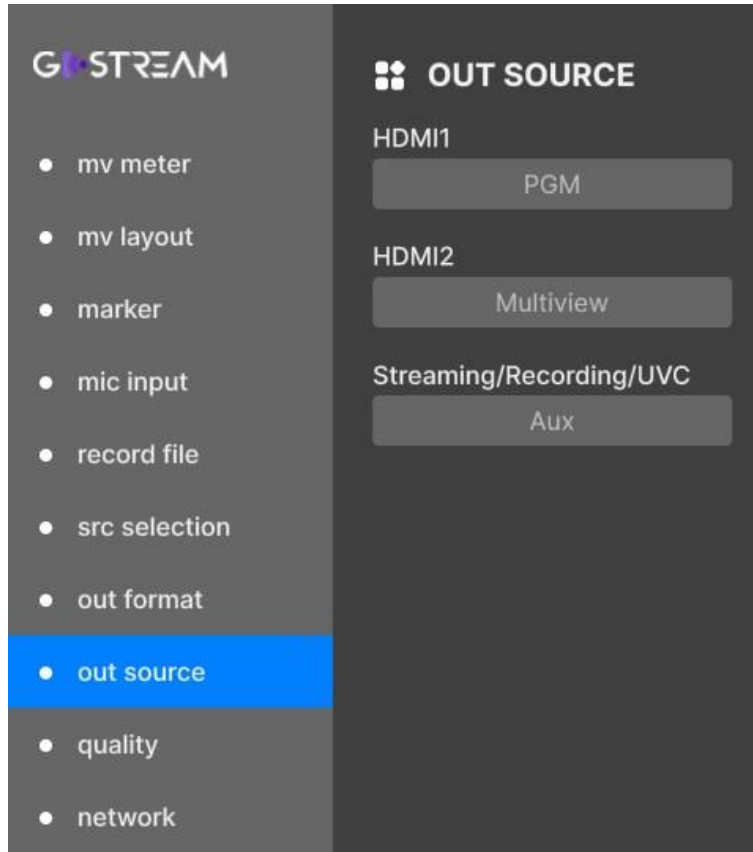

Figure 5.1-25 Setting Output Source

i Tips

- The videos recorded into SD card by recording operation usually are called UVC, and it could be assigned as IN1, IN2, IN3, IN4, AUX, PGM, PVW or Multiview.

5.1.16.6 Restoring your Settings

Here's how to restore your factory reset:

- Go to the menu bar and select **Setting→reset→Factory Reset**.
- A prompt will ask whether you will make sure for this operation. Click 'restore' to confirm this operation.

This can be useful if you want all parameters to be set back to the defaults.

5.2 Menu Settings

When checking or modifying the value of the menu item, cooperating with the following buttons: MENU button and Adjust knob.

1. Operations to the Main menu

■ Display the Main Menu

Press **MENU** button to enter into the main menu, it displays at the bottom right corner of the screen.

■ Switch menu items

After displaying the main menu, scroll the knob clockwise or counterclockwise to choose a menu item, the menu item selected is in highlight.

■ Back to the Main menu

After entering to a sub-menu item or a sub-menu item value, press **MENU** button to back to the upper level menu area.

■ Close the Main menu

Press **MENU** button to close the Main menu.

2. Operations to sub-menu item

■ Display the sub-menu item

After display the Main menu, scroll the knob clockwise or counterclockwise to select a menu item, and the right part displays its sub-menu items according to the current selected menu item.

■ Switch sub-menu items

After displaying the sub-menu items list, press **MENU** button to enter into the sub-menu items list, scroll the knob clockwise or counterclockwise to choose a sub-menu item.

■ Back to menu item

After entering to the sub-menu item value, press **MENU** button to back to menu items, the control icon is back to the corresponding sub-menu item.

3. Operations to sub-menu item value

■ Switch sub-menu item value

When the control icon is in sub-menu item value, scroll the knob clockwise or counterclockwise to switch among its value list.

■ **Confirm the modification to sub-menu item value**

Press the knob straight down to confirm the selection of a value, and the control icon is back to the corresponding sub-menu item.

■ **Abandon the modification to sub-menu item value**

Press **MENU** button to give up the modification to sub-menu item value.

Chapter 6 Specifications

1. Product detailed information

Specification	Values		
Model	GoStream Deck (HDMI Switcher)		GoStream Duet (SDI Switcher)
Video Input Interface	HDMI × 4	HDMI Input	----
	SDI × 4	HDMI Input	SDI Input
	USB X1	USB2, Webcam Input	
Video Output Interface	HDMI × 1	OUT1, HDMI Output	
	HDMI × 1	OUT2, Multiview(10 up views including Program, Preview, 4 HDMI inputs, SuperSource, Media Player, Still Images, Streaming Status, Recording Status and Audio Meters)	
	USB X1	USB1, Webcam Output	
Audio Input Interface	MIC × 2	3.5mm Jack	
Audio Output Interface	MIC × 1	3.5mm Jack(Headphone)	
Control Interface	Ethernet X1	Streaming on live	
Signal Output Formats	HDMI	1080p24, 1080p25, 1080p30, 1080p50, 1080p60, 1080P23.98, 1080P29.97, 1080P59.94	
Video Specifics	Upstream Keyer	4	
	Downstream Keyer	2	
	Color Generators	2	
	Pattern Generator	18	
Audio Mixer	2 channel analog audio inputs 4 channel HDMI embedded audio inputs 1 channel AUX embedded audio input 1 channel PGM monitoring		
Dimension (W x H x D, mm)	252.4*49.3*107.3		268.6*49.3*107.3
Weight	0.5kg		0.56kg
Power Consumption	12W		15W
Input Power	12VDC		

Specification	Values
Work Environment	Temperature: 0~70°C
	Humidity: 10%~90% (no condense)
	Height: below 1000 feet (3048 meter) above sea level

2. Dimensions

The description of the product dimensions is shown as in the following figures:

■ GoStream Deck HDMI Switcher

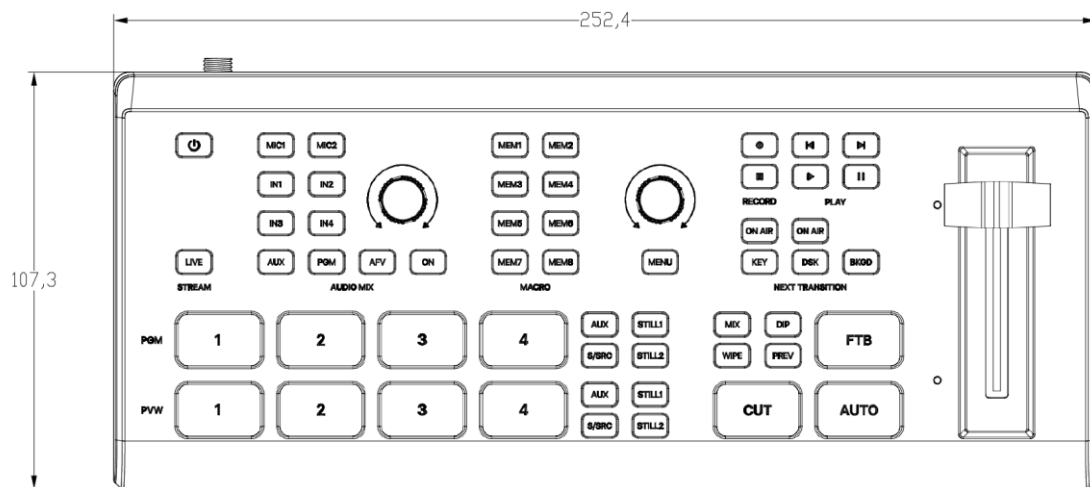

Figure 6-1 Front Panel(Unit: mm)

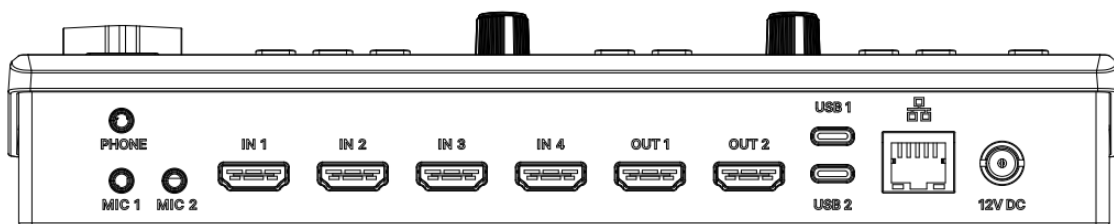

Figure 6-2 Rear Panel(Unit: mm)

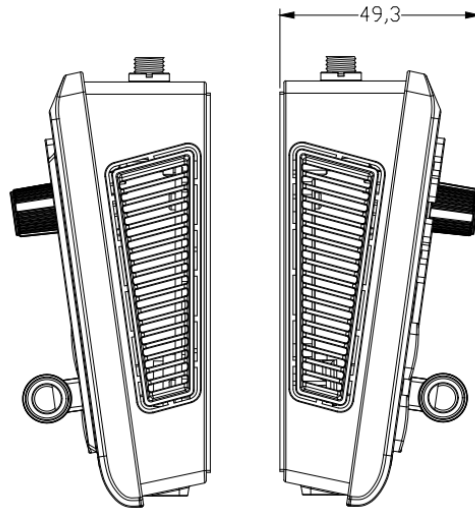

Figure 6-3 Side View(Unit: mm)

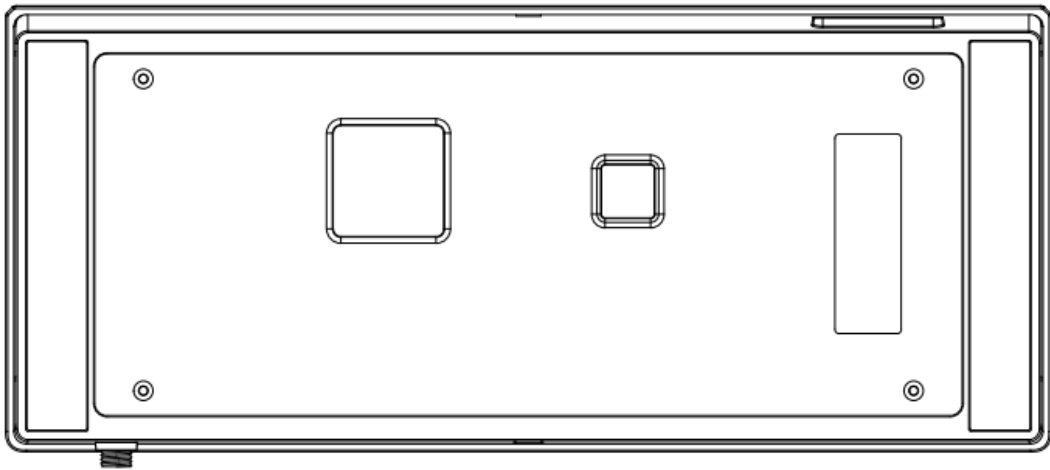

Figure 6-4 Back View(Unit: mm)

- GoStream Duet SDI Switcher

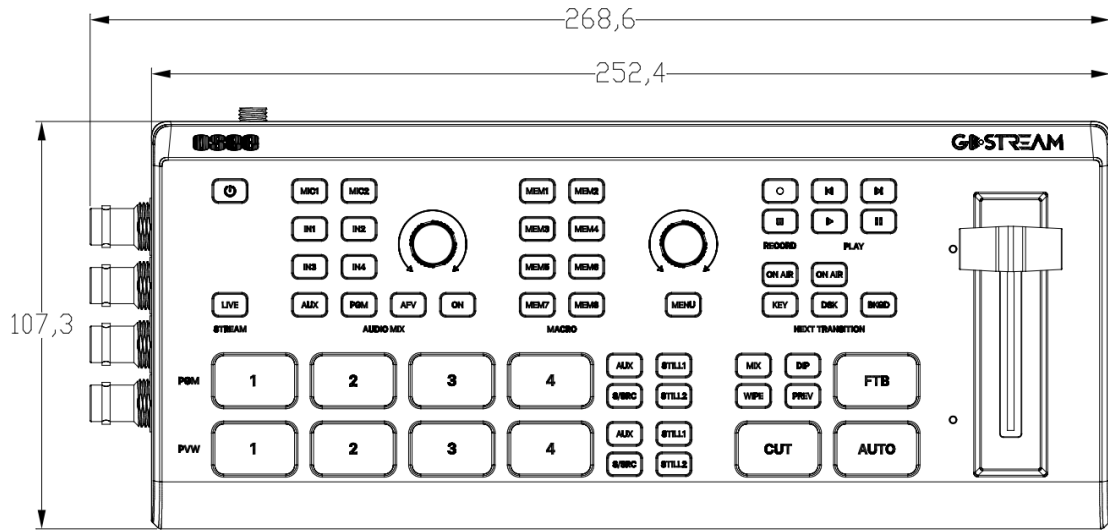

Figure 6-5 Front Panel(Unit: mm)

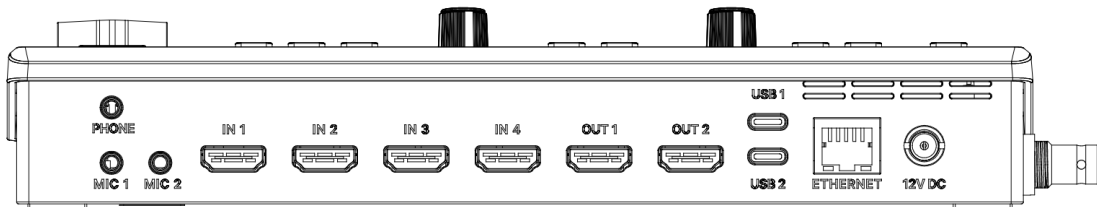

Figure 6-6 Rear Panel(Unit: mm)

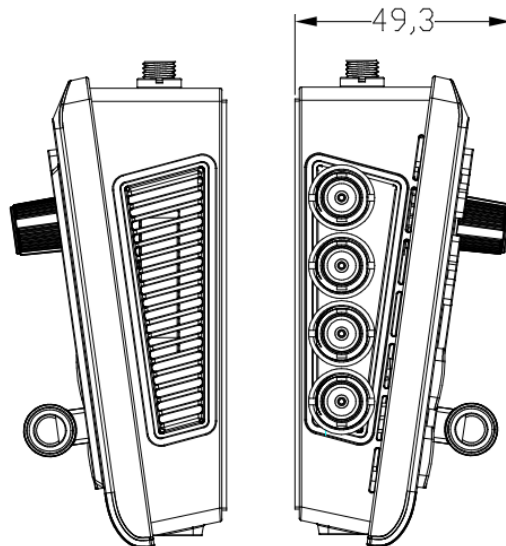

Figure 6-7 Side View(Unit: mm)

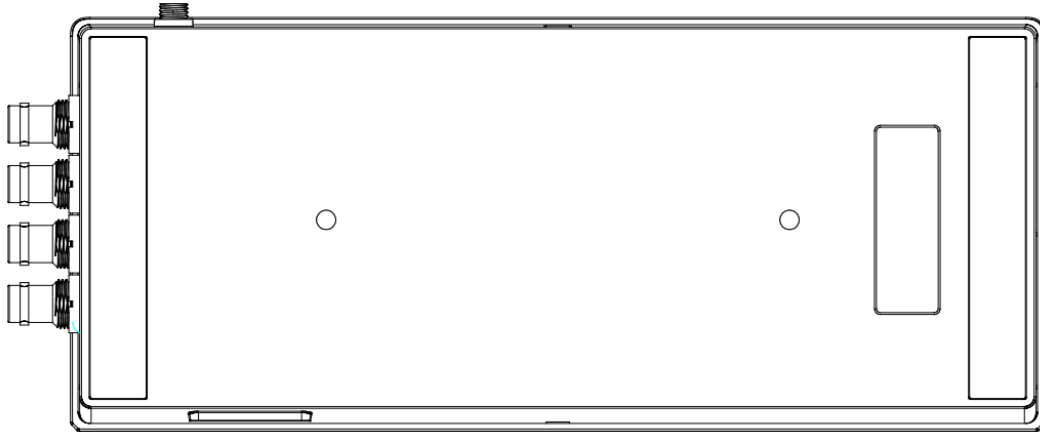

Figure 6-8 Back View(Unit: mm)

i Tips

- Specifications are subject to change without notice.
-

-----No Text Below-----



FOR MORE INFORMATION PLEASE VISIT: <http://www.osee-dig.com/>
OSEE TECHNOLOGY LTD.

No.22 Building, No.68 zone, Beiqing Road, Haidian District, Beijing, China

Tel: (+86) 010-62434168, Fax: (+86) 010-62434169

E-mail: sales@osee-dig.com